

WOODY

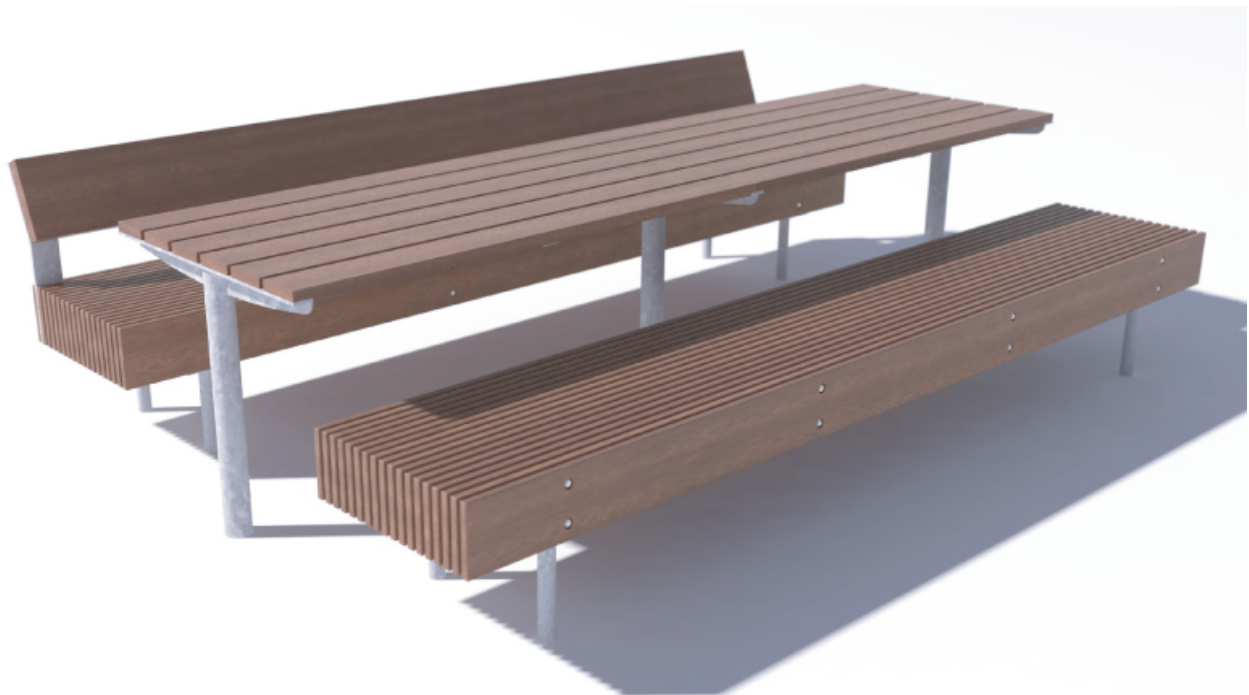

Märket för
ansvarfullt
skogsbruk



WOODY parkmöbel är inspirerad av naturen. Dess massiva sits består av ett antal stående brädor. Brädorna lämnas obehandlade, och är endast impregnerade mot skadedjur, för att naturligt åldras vilket också ger ett minimalt underhåll.

Woody levereras i moduler för att arrangeras i olika linjära eller slutna formationer. Lösningar med funktioner såsom cykelställ och stamskydd är också möjligt.

I serien ingår: Bänk, Sofa, Bord.

Design: David Karásek, Radek Hegmon

WOODY

m m
cité 1



Märket för ansvarfullt skogsbruk

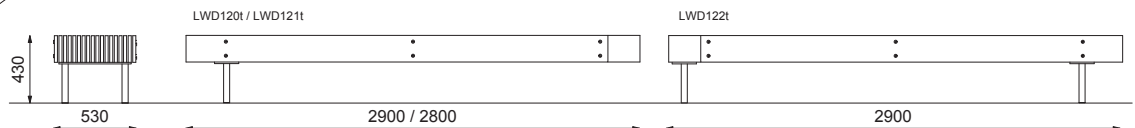
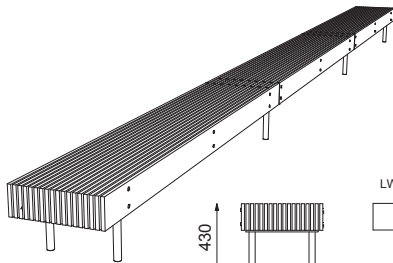
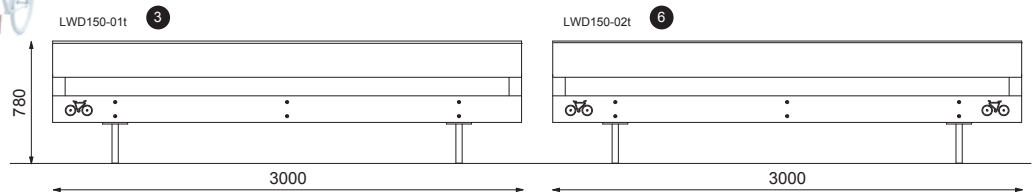
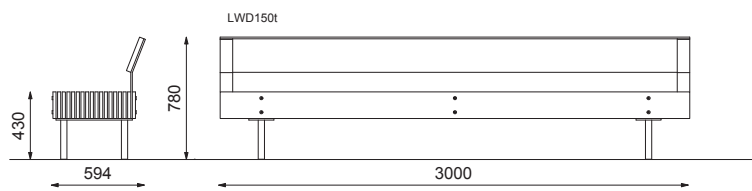
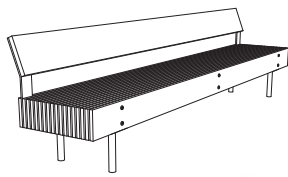
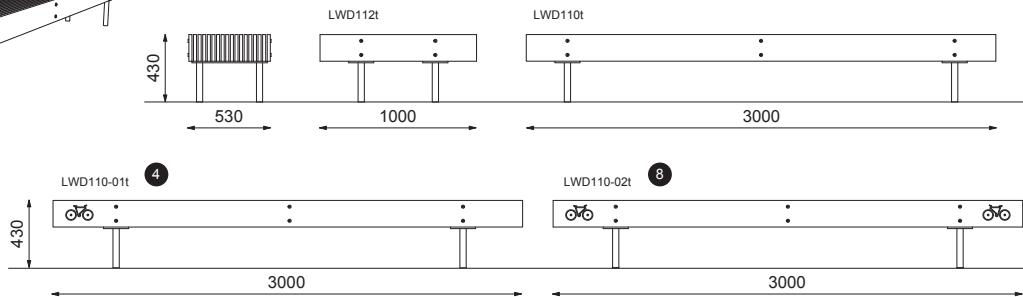
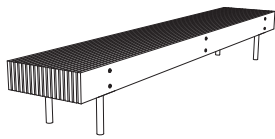

WOODY bord

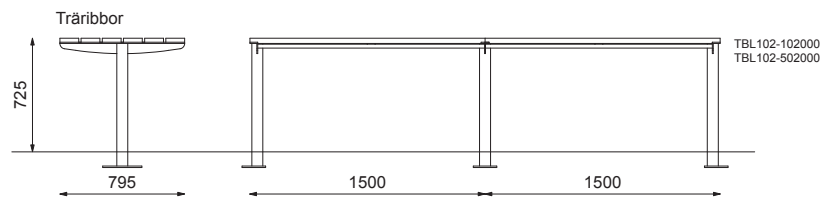
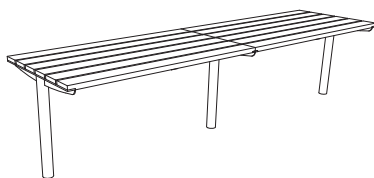

Material: Stomme: Stål. Varmförzinkat.
Sits och ryggstöd: Jatoba (t).
Bordstomme: Stål (förzinkat och pulverlackerat).
Bordskiva (ribbor): Jatoba, Robinia.
FSC-certifierad Jatoba.
Variant: Bänk, Sofa, Sofa med integrerat cykelställ, Bord.
Fastsättning: Fastbultning
Design: David Karásek, Radek Hegmon

WOODY

m m
cité 1



Märket för ansvarfullt skogsbruk

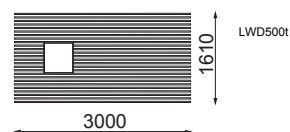
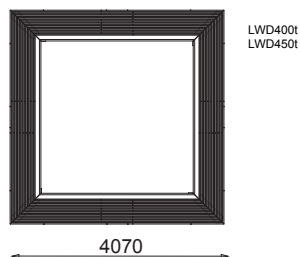
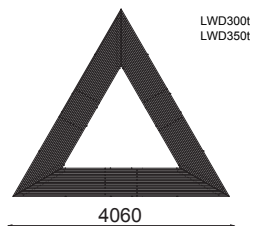
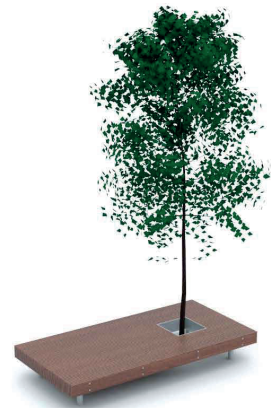
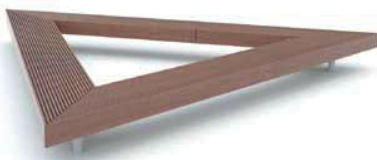
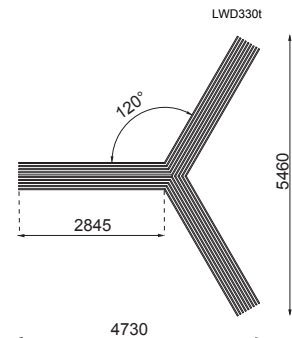
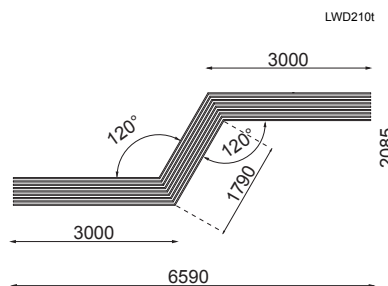
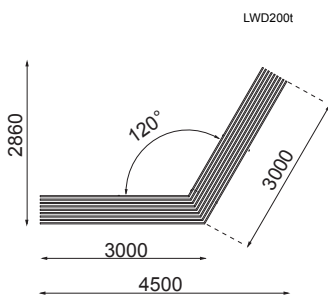

WOODY

mm
cite 1

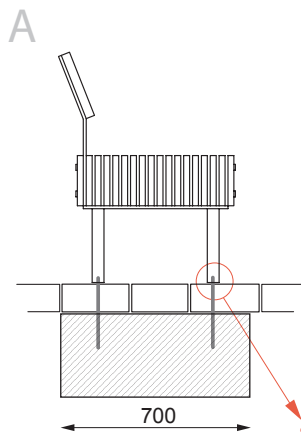
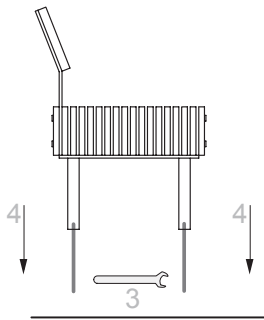

se detalj för fundamentering

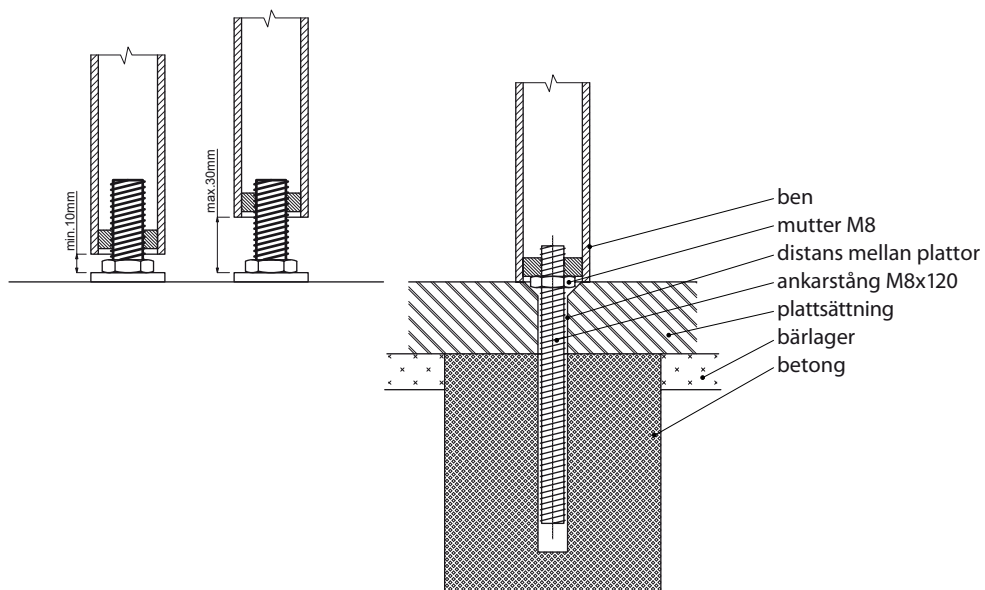
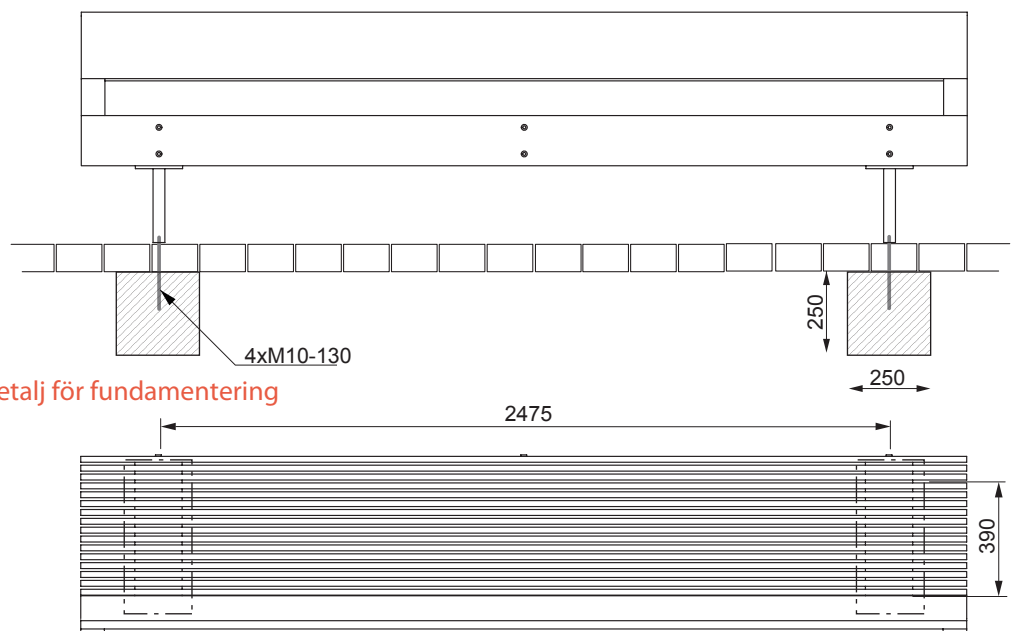

WOODY

mm
cite 1

