

# IAC Duct Silencer Catalogue

A complete range of engineered noise control for air-handling systems



# Introduction

## Why Laboratory Tested Silencers Are Best

Rectangular and cylindrical duct silencers from IAC Acoustics provide effective and predictable noise reduction at substantial savings over other methods due to our products being laboratory developed and tested under controlled conditions.

To assure this, silencers are periodically tested in our accredited aero-acoustic laboratory. This practice of quality control performance testing ensures that all silencers exhibit catalogued Dynamic Insertion Loss (DIL), Self-Noise (SN), and pressure drop performance data.

**Since 1950, professional engineers have specified modular duct silencers from IAC Acoustics with the confidence to control all types of noise sources in air handling systems. Below are just a few reasons why:**

### Silencers are a necessity in Air Handling Systems

The advent of high-performance HVAC equipment has resulted in unacceptably high noise levels both in low and high frequencies. This creates a need for more stringent noise control specifications in air conditioning systems. Performance rated silencers provide the most effective and economical solutions.

More reliable noise data has become available from manufacturers of Air Handling components. Therefore, the use of silencers which are accurately rated under operating conditions contributes to the achievement of the desired noise criteria.

### Predictable performance is Assured with IAC Silencers

IAC Acoustics' silencers are rated under operating conditions in the most advanced aero-acoustic R&D laboratory available. Regardless of their size or configuration our silencers are developed, tested, and rated in accordance with the most current industry standards. There is no guess work with hit-or-miss empirically developed calculations or otherwise inaccurately rated silencers.

### Duct Lining and Silencers

In most cases, the use of duct lining alone cannot sufficiently attenuate the noise from air handling equipment. The high volume production of quality-controlled standardised components brings our duct silencers within budget of any project. Proper structural design assures a long and trouble-free life.

## Page

|       |   |
|-------|---|
| 4     | IAC's Duct Silencer Design  |
| 4     | Duct Silencer Development   |
| 5     | Why so Many Sizes & Types of Silencer   |
| 6     | The IAC Aero-acoustic Laboratory  |
| 7     | Active & Passive Silencer Designs   |
| 7     | Sources of Design Information   |
| 8     | IAC Silencer Optional Additions   |
| 8     | Operation & Maintenance of IAC Silencers  |
| 9     | Guidelines for Location & Installation of IAC Silencers                         |
| 12    | Short Form IAC Silencer Design  |
| 14    | Specifications for Quiet-Duct® Rectangular & Conic-Flow™<br>Tubular Silencers   |
| 16-47 | Data Sheets - LFS, LFM, S, SM, ES, MS, LFL, ML, L, CS/CL,<br>FCS/FCL, NS/NL, EC |
| 48    | Specifications for Clean Flow™ Rectangular Silencers                            |
| 50-63 | Data Sheets - HLFS, HLFM, HS, HMS, HLFL, HL, HML                                |
| 64    | Specifications for D-Duct Diffuser Silencers                                    |
| 66    | Data Sheet - DDS22-28   |
| 68    | Specifications for Ultra-Pals Rectangular & Tubular Packless<br>Silencers       |
| 70-81 | Data Sheets - XM, XL, KM, KL, TXS, TXL, TXLB                                    |
| 82    | Other IAC Products  |

## Exclusive Features Highlight IAC's Duct Silencer Design

1. Die-formed single-piece splitter constructed throughout
2. Shell-noise radiation minimised by splitter construction in most models
3. Acoustic splitters designed for maximum attenuation at low frequencies, the toughest job of all
4. Straight-through air passages designed for maximum air handling at minimum pressure drop
5. Solid, rounded noses that increase noise reduction
6. Bell-mouth entrance and exit to minimise turbulence, pressure drop and self-noise
7. No protruding fastener heads to cause turbulence or self-noise
8. Solid air-impingement surfaces and self-cleaning air passages to minimise dirt entrapment
9. Acoustic fill protected against erosion by perforated metal containments

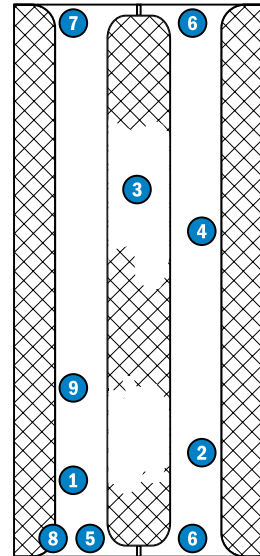

## Duct Silencer Development

IAC Acoustics was founded in 1949, and our first air conditioning silencers were developed in 1950. Since then, we have pioneered the development of performance rated silencers to ensure quiet air handling systems. To maintain this position of leadership, we operate fully equipped state-of-the-art aero-acoustic laboratories. These facilities are not only used for development of new silencers and other noise control products, but also for quality control purposes.

In 1965, for the first time in the noise control industry, we began offering duct silencers with air flowing through them and an accurate acoustic performance rating. IAC introduced the term "Dynamic Insertion Loss" (DIL) to report noise reduction with airflow, and "Self-Noise" to describe the noise generated by the air flowing through the silencer itself. Furthermore, aerodynamic and acoustic performance was

measured in one test facility, on the same silencer, and under specific repeatable conditions.

### Forward and Reverse Flow

In 1972, we developed silencer Dynamic Insertion Loss and Self-Noise ratings both under Forward Flow (+) and Reverse Flow (-) conditions for rectangular and cylindrical silencers.

Since attenuation values are generally higher in the first five octave bands in the Reverse Flow mode compared to the Forward Flow mode, more economical silencer selections can often be made on return-air systems.

These phenomena are illustrated on the right.

### Manufacturing Facilities

IAC operates modern equipped manufacturing plants in the United Kingdom, USA, France, China and

Australia. With numerically controlled automated machinery, these facilities are operated by trained personnel with more combined experience in the noise control industry than any other organisation engaged in a related activity.

Forward Flow occurs when air and sound waves travel in the same direction, as in an air conditioning system or fan discharge. Under forward flow conditions, high frequency sound is refracted into the duct silencer walls.

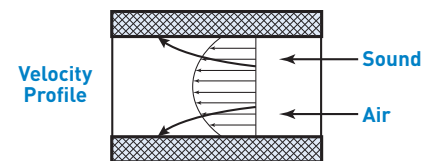

Reverse Flow occurs when air and sound waves travel in opposite directions, as in a typical return-air system. Under reverse flow conditions, sound is refracted away from the walls and towards the centre of the duct silencer.

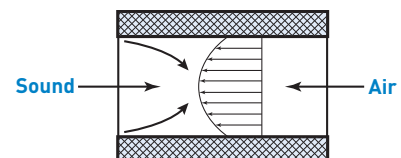

## Why so Many Sizes & Standard Types of Silencers

All of our silencers were developed in response to specific requirements from acoustic consultants, consulting engineers, owners and contractors. They provide the most economical choices for solving the wide diversity of noise control problems encountered in HVAC engineering.

Our standard single module rectangular silencer cross sections range from 150mm x 150mm to 1800mm x 1200mm. For small mains, branches, and duct run-outs, there are module sizes to fit every need. When large silencer banks are required, multiple-module assemblies can be arranged to provide almost limitless dimensional flexibility.

### Quiet-Duct® Rectangular Silencers

Available for conventional applications including “Low Frequency”, IAC silencers have acoustic performances which have been specifically engineered for the 63Hz, 125Hz, and 250Hz octave bands.

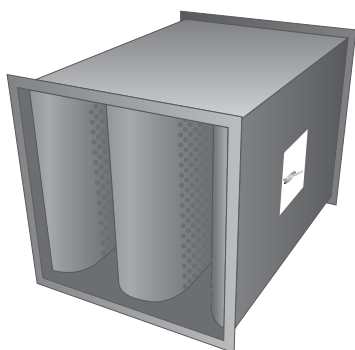

### Clean-Flow™ Rectangular Silencers

Available for systems requiring a higher degree of cleanliness and hygiene such as hospitals or clean room applications. Linings on the fill material guard against erosion of particulate matter into the airstream. Specific internal construction features protect the lining against chafing or premature failure and are necessary to maintain the rated aero-acoustic performance.

### Conic-Flow® Tubular Silencers

Like our Quiet-Duct®, our Conic-Flow® range has been specifically engineered for the 63 Hz, 125 Hz, and 250 Hz octave bands.

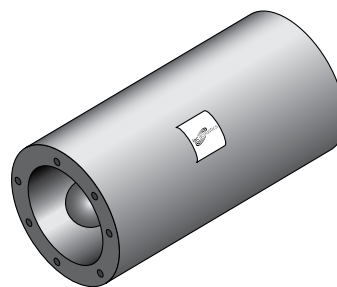

### D-Duct Acoustic Diffuser Silencers

Available for use on axial fan systems. The combined interior diffuser cone and exterior square jacket casing make these units aerodynamic regain devices as well as silencers.

### Rectangular Ultra-Pals™ Packless Silencers

Available as the ultimate solution for ultra-clean environments and corrosive/flammable environments. The complete absence of fill makes our packless silencers ideally suited for hospital, clean-room, pharmaceutical, food, electronics manufacturing, or any other applications where particulate matter or fibre erosion from conventional fill materials could contaminate the air/gas streams. For corrosive / flammable environments the complete absence of fill, combined with ease of cleaning and draining, makes Ultra-Pals™ well suited for engine test cells, chemical plants, refineries, and facilities handling petrol, grease, solvents, and other hazardous materials.

### Tubular Ultra-Pals™ Packless Silencers

Available for small diameter circular duct systems such as fume hoods. However, the packless design of these makes them equally applicable to the types of systems mentioned for the rectangular packless silencers.

### Special Silencers

Developing special silencers is something we have become well known for over the years. Many of today's standard silencer offerings started out as specials. Should none of our standard silencers meet your requirements, we will develop one for your needs.

## The IAC Aero-Acoustic Laboratory

### Performance Certification

Our aero-acoustic research centre permits forward and reverse flow, Dynamic Insertion loss, Self-Noise, and pressure drop rating of silencers and other elements in a closed loop wind tunnel and other facilities. Dual reverberation rooms also permit testing of system components or assembled air handling units. Our aero-acoustic laboratory is accredited by the National Institute of Standards and Technology, National Voluntary Lab Accreditation Program (NVLAP) for acoustical testing services.

For today's highly specialised markets, it is essential for an engineering and manufacturing organisation to operate its own development and test facilities to advance the existing technology, and assure the quality of its products.

In 1963, IAC Acoustics built the first full-size dynamic duct-to-reverberant room test facility. Two years later, dynamic silencer ratings were published, though the forward flow mode only. For several years afterwards, IAC had the only facility capable of measuring air flow, pressure drop, dynamic insertion loss, and self-noise. Even today, there are few, if any, other facilities with capabilities equal to those of IAC's.

In 1972 the dedication to product improvement and the desire to provide better rating information for design

engineers prompted a modification to the test facility. The improved arrangement permitted silencers also to be tested in reverse flow mode.

In 1974 the laboratory was moved to its present location in New York, and equipped with a controllable pitch vane-axial fan and made part of a closed loop system.

The aero-acoustic duct-to-reverberate room laboratory is in use daily for testing special designs, developing new products and for quality control of existing standard designs. The laboratory provided a major impetus for the ASTM standard method of testing E 477 for pre-fabricated silencers. All IAC Acoustics' silencers are tested in accordance with applicable portions of the ASTM, British and ISO standards.

Silencer performance data extrapolated from other sources or arrived at by computer, through a seemingly educated form of guesswork, remains highly unreliable. Consultants specifying any type of silencers should insist on certified and verifiable data measured in an aero-acoustic laboratory in accordance with the ASTM standard E 477, British Standard 4718 or ISO 7235.

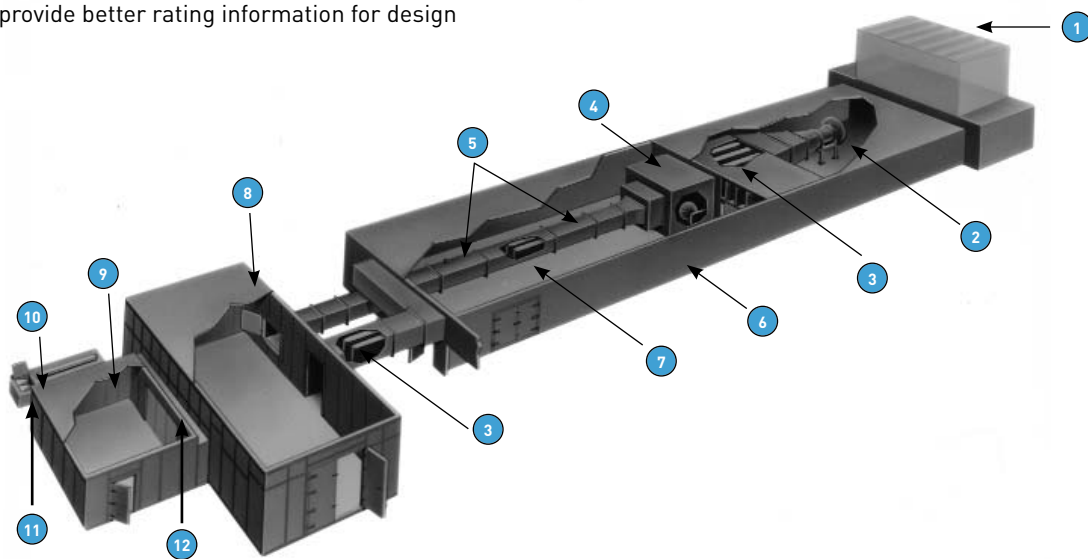

1. Removable hatch in roof for testing silencers up to 3.05m x 3.05m cross section
2. 42,480m<sup>3</sup>/hr vane-axial fan
3. Systemic silencer
4. Plenum with loud-speaker and flow diffuser
5. Test unit pilot tube ports
6. Super-Noise-Lock housing

7. Test silencer
8. 283m<sup>3</sup> reverberation receiving room
9. 85m<sup>3</sup> reverberation source room
10. 76mm impedance tube
11. 610mm x 610mm anechoic wedge impedance tunnel
12. 4.3m x 2.7m test frame for transmission loss tests

## Active & Passive Silencer Designs

All of the silencers manufactured by IAC Acoustics are of the passive design as they do not require mechanical or electrical means to function. They do their job very simply by providing a trouble free static means for the dissipation of sound energy by converting it into very minute quantities of heat.

Many of the original air conditioning silencers developed by IAC Acoustics in 1950 are still in use today.

Active silencers are operated electronically by means of microprocessors, loudspeakers and microphones. They cancel sounds by feeding back an additional noise source which is 180 degrees out of phase with the original noise. In theory, the result is that at certain low frequencies, usually below 300 Hz, the noise can be

effectively reduced. Initial research to develop a commercial product was particularly strong in the UK but today research goes on throughout the world.

However, HVAC noise control requirements are rarely confined to a narrow low frequency range. The broad band low and high frequency attenuation capabilities of typical passive silencers are practically always required. Also today's passive silencer selections include 'Low Frequency' models offering certified performance similar to what would be expected from an otherwise active system. Passive silencers combine low cost, simple installation and maintenance free life time operation to make them the natural choice in HVAC engineered noise control.

## Sources of Design Information

The effective and economical application of noise control methods depends on an accurate knowledge of the systems' silencing requirements. An under-silenced job is costly. There are several sources of information available for determining the required noise reduction for a wide range of HVAC applications.

The ASHRAE guide presents a procedure for calculating the noise reduction required. IAC offers several methods which conform to the guide and yield accurate methods.

Use the IAC Acoustics SNAP Form when the entire HVAC air distribution system is to be evaluated. The analysis starts with the acoustic criterion for the

occupied space and then accounts for the system effects of each component such as terminals, mixing boxes, branch take-offs, elbows, duct-work, fan sources, plus room characteristics.

When cross-talk noise transmissions are the problem, one simple rule applies, silencers installed in the connecting duct-work between spaces must provide airborne noise reduction to at least match the sound transmission loss of the separating structure.

When choosing between the many types of silencers available from IAC Acoustics, refer to the short form availability guide on pages 12-13 of this catalogue. This guide lists the most effective model of silencer in a particular category (i.e.

rectangular, tubular and packless) based on 250 Hz octave band DIL attenuation. It also lists typical applications where individual silencer models would often be used. Once a particular model has been selected, more complete aero-acoustic data can be found on the technical data sheets for that model, which follow in this catalogue.

If further information is required, please contact IAC at [winchester@iac-acoustics.com](mailto:winchester@iac-acoustics.com) or visit our website: [www.iac-acoustics.com](http://www.iac-acoustics.com)

## IAC Silencer Optional Extras

- Circular spigot ends
- Slide on flanges
- Angle flanges
- Vertical or horizontal splitter orientation
- Melinex wrapped infill
- Glass cloth wrapped infill
- Honeycomb stand-off for Clean-Flow™ silencers
- Hospital specification – Melinex and honeycomb
- Casing thicknesses in a range of sizes
- Double skinned construction
- Polyester Powder Coating (PPC)
- Chlorinated rubber paint
- Construction materials, including galvanised mild steel, stainless steel & aluminium
- Integral inlet and outlet plenums



## Operation & Maintenance for IAC Silencers

1. IAC Silencers have no moving parts and therefore require no lubrication or routine maintenance.
2. All silencers are furnished rigidly constructed, well-made, and free from any defects in materials or workmanship. To ensure continuing proper operation, the silencers should be visually inspected at least once a year to verify that:
  - a. Perforated acoustic splitters are undamaged, remaining parallel and true.
  - b. Airspace between the acoustic splitters are free from any debris.
  - c. The holes in the perforated steel are open and free of dust or other foreign matter.
3. In the event that debris must be cleaned from the airspaces or the perforated metal, the silencer should be vacuum-cleaned or wiped clean with a cloth dampened in mild detergent solution.
4. In no event should solutions be used to clean IAC silencers that might affect the galvanised protection on the steel.
5. The occurrence of 'White Rust' (zinc oxide) on galvanised silencers is a normal event and not a maintenance item. It occurs when the zinc in the galvanising reacts electrolytically with moisture to protect the steel.
6. In the event of fire, flood, structural damage or other severe occurrences, contact IAC's Building Services Division for specific instructions and recommendations.
7. For further technical data please refer to 'Guidelines for the location and installation of IAC silencers' on pages 9-11 of this guide.



## Guidelines for the Location & Installation of IAC Silencers

The following practical information shows the designer and installer how and where to use silencers. These guidelines are divided into two sections:

### 1. Field Assembly & Duct Connections for Rectangular Silencers

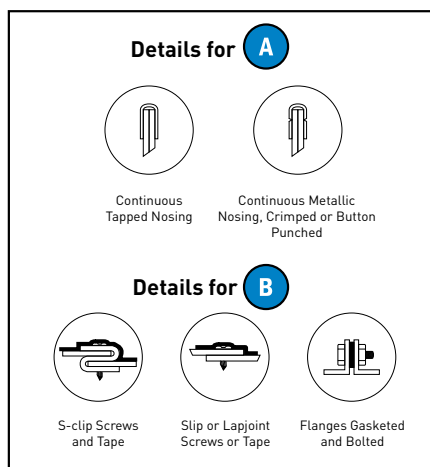
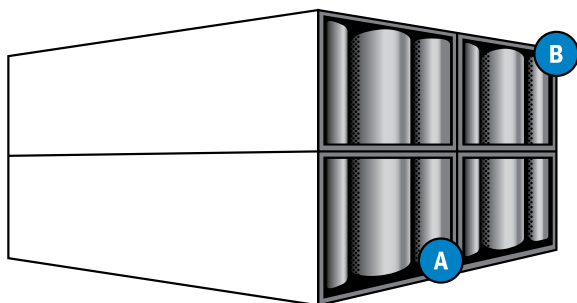

#### Notes

1. For maximum structural integrity, IAC Quiet-Duct® Silencer splitters should be installed vertically. When vertical installation is not feasible, structural reinforcement is required for silencers wider than 600mm.
2. Unless otherwise indicated, connecting duct-work is assumed to have the same dimensions as fan intake or discharge openings.
3. When elbows precede silencers, splitters should be parallel to the plane of elbow turn.
4. L1 = Distance from fan exhaust to entrance of discharge silencer.  
L2 = Distance from fan inlet to exit of intake silencer.
5.  $\Delta P$  Factor = Pressure Drop multiplier relative to silencer laboratory rated data.
6. D = Diameter of round duct or equivalent diameter of rectangular duct.
7. Unless otherwise noted, multipliers shown do not include pressure drop of other components (elbows, transitions, dump losses etc), which must be calculated separately.
8. The  $\Delta P$  Factors given are subject to minimum duct runs of 2.5 D after discharge silencers and 2.5 D before intake silencers. Otherwise, use additional multipliers as shown, such as for fans, elbows and silencers immediately at system entrance or exit, or for other system components.

### 2. Locating Silencers in Relation to Other System Components

The purpose of the next few pages is to provide guidelines for locating IAC silencers in air handling systems. In addition, it provides a rapid means of estimating the combined Pressure Drop due to air-flow through the silencer as it is affected by the silencers location with respect to the other system components such as fans, coils, elbows, and others.

The airflow and pressure drop data are based on tests run in accordance with applicable sections of internationally recognised test codes. These codes specify minimum lengths of straight duct connections up and downstream of the components under test. However, in practise, because of space considerations, it is often necessary to install silencers under conditions which vary significantly from the test procedure. Therefore the effect of these variations must be included to determine the resultant pressure drop of air flow through the silencer.

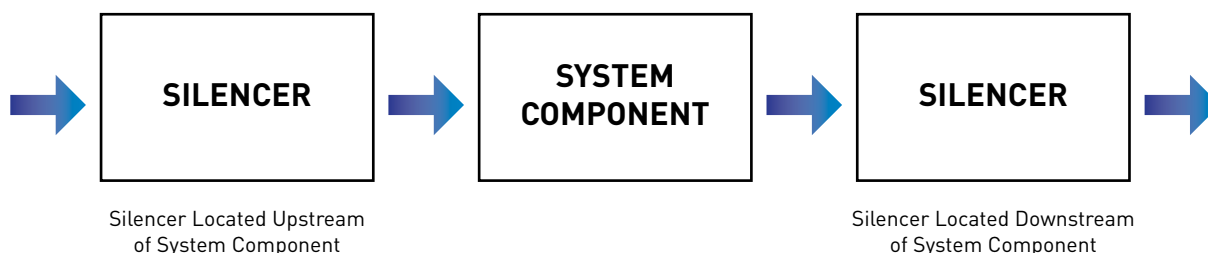

## Guidelines for the Location & Installation of IAC Silencers

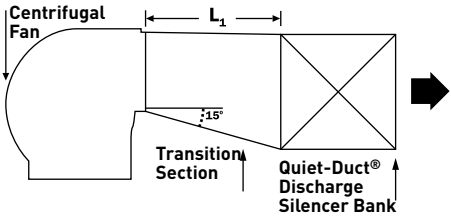
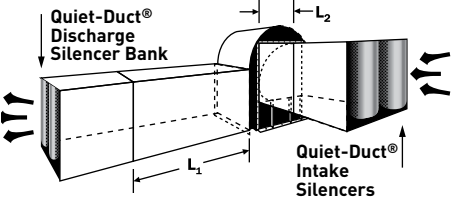
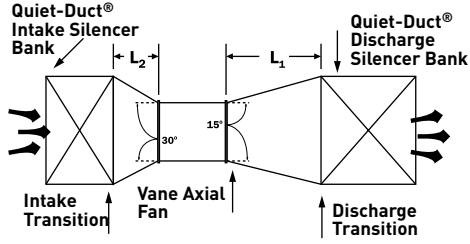
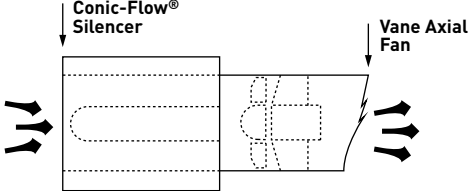
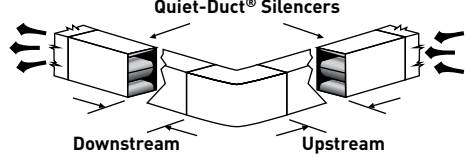
| Location of Silencers Relative to Fans   | ΔP Factor Silencer |             | Diagram  |
|--|--------------------|-------------|--|
|  | Up Stream          | Down Stream |  |
| <p><b>Ducted Centrifugal Fans</b></p> <p><b>Discharge - Quiet-Duct® Rectangular Silencers</b></p> <p>a. L1 = one duct diameter for every 5m/s average duct velocity including suitably designed transition section for maximum regain</p> <p>b. If space is limited, velocity distribution vanes, diffusers, or other flow equalisers will have to be provided by system designer. Allow minimum L1 = 0.75 D</p> <p><b>Intake - Quiet-Duct Rectangular Silencers</b></p> <p>Use minimum L2 = 0.75 D including suitably designed transition sections if required</p>  | -                  | 1.0         |  <p>Centrifugal Fan</p> <p>Transition Section</p> <p>Quiet-Duct® Discharge Silencer Bank</p> <p>Recommended Transition Section Arrangement Between Centrifugal Fan and Silencer Bank (Ducting not Shown)</p>  <p>Quiet-Duct® Discharge Silencer Bank</p> <p>Quiet-Duct® Intake Silencers</p> <p>Intake and Discharge Silencers for Centrifugal Fans (Ducting not Shown)</p>  |
| <p><b>Ducted 50% Hub-Vane Axial Fans</b></p> <p><b>Discharge - Quiet-Duct® Rectangular Silencers</b></p> <p>a. L1 = one duct diameter for every 5m/s average duct velocity including transition sections of not more than 30° included angle for maximum regain</p> <p>b. When space is limited, velocity distribution vanes, diffusers, or other flow equalisers will have to be provided by system designer. Allow minimum L1 = 0.75 D</p> <p><b>Discharge - Conic-Flow® Tubular Silencers</b></p> <p>L1 = 0 when fan hub is matched to silencer centre body</p> <p><b>Intake - Quiet-Duct® Rectangular Silencers</b></p> <p>Use minimum L2 = 0.75 D including intake cones of not more than 60° included angle</p> <p><b>Intake - Conic-Flow® Tubular Silencers</b></p> <p>L2 = 0 when fan hub is matched to silencer centre body</p> | -                  | 1.0         |  <p>Quiet-Duct® Intake Silencer Bank</p> <p>Quiet-Duct® Discharge Silencer Bank</p> <p>Intake Transition</p> <p>Vane Axial Fan</p> <p>Discharge Transition</p> <p>Recommended Transition Section Arrangement Between Vane-Axial Fan and Silencer Bank (Ducting not Shown)</p>  <p>Conic-Flow® Silencer</p> <p>Vane Axial Fan</p> <p>Conic-Flow® Tubular Silencer Centre Body Matched to Axial Fan Hub (Ducting not Shown)</p> |
| <p><b>Elbows (without turning vanes)</b></p> <p>Distance of silencer from elbow:</p> <p>D x 3</p> <p>D x 2</p> <p>D x 1</p> <p><b>Elbows (with turning vanes)</b></p> <p>Distance of silencer from elbow:</p> <p>D x 3</p> <p>D x 2</p> <p>D x 1</p> <p>D x 0.5</p> <p>Directly connected</p>  | 1.0                | 1.0         |  <p>Quiet-Duct® Silencers</p> <p>Downstream</p> <p>Upstream</p> <p>Silencers Before and After Elbows</p> <p>Note: Silencer baffles should be parallel to the plane of the elbow turn.</p>  |
|  | 1.5                | 1.5         |  |
|  | 2.0                | 2.0         |  |
|  | 1.0                | 1.0         |  |
|  | 1.2                | 1.2         |  |
|  | 1.75               | 1.75        |  |
|  | 3.0                | 3.0         |  |
|  | 4.0                | Not Advised |  |

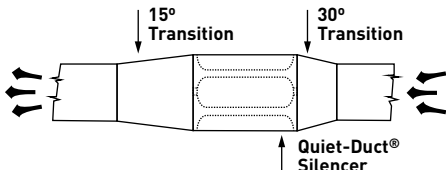
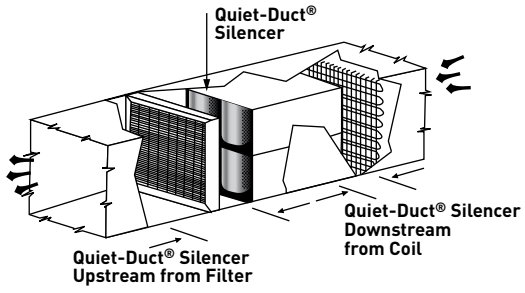
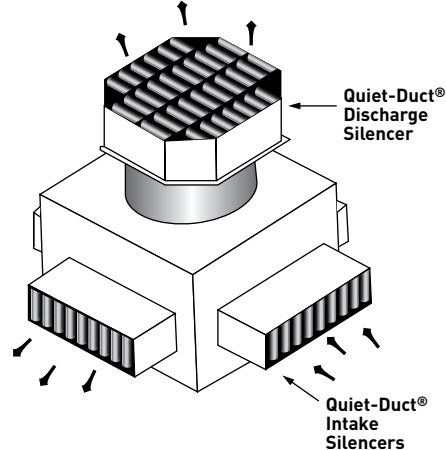
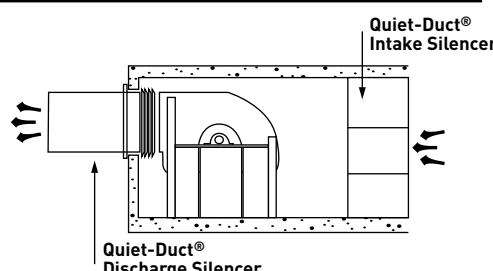
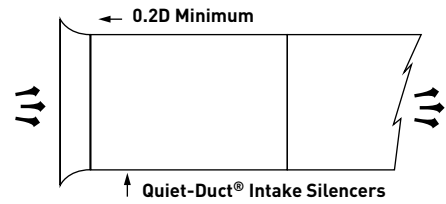
| Location of Silencers Relative to Components   | ΔP Factor Silencer |             |  <p>Silencer between Upstream and Downstream Transitions</p>   |
|--|--------------------|-------------|--|
|  | Up Stream          | Down Stream |  |
| <p><b>Transitions</b></p> <p>With 15° included angle (7.5° slope)</p> <p>With 30° included angle (15° slope)</p> <p>With 60° included angle (30° slope)</p>  | 1.0                | 1.0         |  |
| <p><b>Coils &amp; Filters</b></p> <p>Downstream - 300mm from face</p> <p>Upstream - 600mm from face</p>  | -                  | 1.0         |  <p>Quiet-Duct® Silencer Upstream from Filter</p> <p>Quiet-Duct® Silencer Downstream from Coil</p>   |
| <p><b>Cooling Towers &amp; Condensers</b></p> <p>Type L or Type ML Silencers</p> <p>The pressure drop increase due to the addition of silencers to a cooling tower is partially offset by the resulting decrease in the entrance and discharge losses of the system</p>  | 2.0                | 2.0         |  <p>Quiet-Duct® Discharge Silencer</p> <p>Quiet-Duct® Intake Silencers</p> <p>This multiplier includes typical allowance for intake &amp; discharge dump losses</p> |
| <p><b>Immediately at System Entrance or Exit</b></p> <p><b>Silencer Type or Model</b></p> <p>CL, FCL</p> <p>NL</p> <p>ML</p> <p>CS, FCS, NS, HL, LFL</p> <p>MS, LFM, HLFM, KM, KL</p> <p>S, ES, SM, LFS, HLFS, XM, XL</p> <p>The relatively higher multipliers for the lower pressure drop silencers, such as the CL and L Type, for instance, are due to the dump losses to the atmosphere being significantly higher relative to their rated values.</p> | 2.0                | 5.0         |  <p>Quiet-Duct® Discharge Silencer</p> <p>Quiet-Duct® Intake Silencer</p> <p>Silencers Immediately at Intake and Discharge of Equipment Room</p>                   |
| <p>Pressure drop factors for silencers at the entrance to a system can be materially reduced by use of a smooth converging bell mouth with wide sides having a radius equal to at least 20% of its outlet dimension</p>  |                    |             |  <p>← 0.2D Minimum</p> <p>Quiet-Duct® Intake Silencers</p>   |

## Short Form Silencer Availability Guide

### 250 Hz DIL Attenuator Comparisons

#### Quiet-Duct® Rectangular

| Page | Silencer Type | Face Velocity | Self Noise Lw | DIL, dB at 250 Hz |      |      |      | Pressure Drop in N/m <sup>2</sup> |      | Application   |
|------|---------------|---------------|---------------|-------------------|------|------|------|-----------------------------------|------|---|
|      |               |               |               | Length (mm)       |      |      |      | Length (mm)                       |      |   |
|      |               | m/s           | dB            | 900               | 1500 | 2100 | 3000 | 900                               | 3000 |   |
| 16   | LFS           | 5.0           | 45            | 22                | 31   | 37   | 47   | 142                               | 177  | Low and medium velocity systems requiring superior low frequency DIL acoustic performance. Used in-line with filter/coil banks or in medium velocity duct-mounted installations.<br><br>Low and medium velocity systems requiring good low and high frequency attenuation for broad spectrum performance at medium pressure drops.<br><br>Higher velocity systems where improved low frequency acoustic performance is required at lower pressure drop. Higher velocity systems requiring low and high frequency attenuation for broad spectrum performance at the lowest pressure drops. |
| 18   | LFM           | 5.0           | 36            | 15                | 23   | 30   | 39   | 47                                | 60   |   |
| 20   | S             | 5.0           | 35            | 15                | 23   | 31   | 41   | 90                                | 122  |   |
| 22   | SM            | 5.0           | 46            | 14                | 21   | 29   | 38   | 50                                | 78   |   |
| 24   | ES            | 5.0           | 33            | 14                | 19   | 31   | 41   | 55                                | 110  |   |
| 26   | MS            | 5.0           | 36            | 12                | 17   | 23   | 32   | 25                                | 47   |   |
| 28   | LFL           | 5.0           | 32            | 14                | 17   | 22   | 29   | 20                                | 25   |   |
| 30   | ML            | 5.0           | 30            | 9                 | 14   | 19   | 25   | 12                                | 22   |   |
| 32   | L             | 5.0           | 37            | 8                 | 13   | 16   | 23   | 12                                | 17   |   |

#### Conic Flow® Tubular

| Page | Silencer Type | Face Velocity | Self Noise Lw | DIL, dB at 250 Hz  |     |      |      | Pressure Drop in N/m <sup>2</sup> | Application  |
|------|---------------|---------------|---------------|--------------------|-----|------|------|-----------------------------------|--|
|      |               |               |               | Pipe Diameter (mm) |     |      |      | Length (mm)                       |  |
|      |               | m/s           | dB            | 600                | 900 | 1200 | 1500 | All Sizes                         |  |
| 34   | CS            | 10.0          | 50            | 18                 | 19  | 20   | 23   | 57                                | High velocity circular duct systems requiring superior low frequency attenuation without sacrificing mid or high frequency performance. Medium pressure drop characteristics.<br><br>High velocity circular duct systems with good low and high frequency attenuation.<br><br>Medium pressure drop characteristics. High velocity circular duct systems with reduced cost and low pressure drop characteristics. |
| 36   | CL            | 10.0          | 46            | 13                 | 16  | 18   | 20   | 15                                |  |
| 38   | FCS           | 10.0          | 50            | 25                 | 29  | 33   | 37   | 37                                |  |
| 40   | FCL           | 10.0          | 46            | 21                 | 24  | 27   | 31   | 12                                |  |
| 42   | NS            | 10.0          | 45            | 14                 | 17  | 19   | 20   | 52                                |  |
| 44   | NL            | 10.0          | 46            | 11                 | 13  | 15   | 15   | 27                                |  |
| 46   | C             | -             | -             | -                  | -   | -    | -    | -                                 |  |

#### Clean Flow™ Rectangular

| Page | Silencer Type | Face Velocity | Self Noise Lw | DIL, dB at 250 Hz |      |      |      | Pressure Drop in N/m <sup>2</sup> |      | Application  |
|------|---------------|---------------|---------------|-------------------|------|------|------|-----------------------------------|------|--|
|      |               |               |               | Length (mm)       |      |      |      | Length (mm)                       |      |  |
|      |               | m/s           | dB            | 900               | 1500 | 2100 | 3000 | 900                               | 3000 |  |
| 50   | HLFS          | 5.0           | 45            | 14                | 23   | 22   | 30   | 142                               | 177  | Fill protected silencers for low, medium and high velocity applications where cleanliness is critical such as hospitals, clean rooms, or laboratories. 'LF' series units are designed for increased low frequency attenuation. |
| 52   | HLFM          | 5.0           | 36            | 10                | 20   | 23   | 27   | 80                                | 100  |  |
| 54   | HS            | 5.0           | 49            | 13                | 18   | 19   | 27   | 90                                | 122  |  |
| 56   | HMS           | 10.0          | 52            | 8                 | 11   | 16   | 23   | 25                                | 47   |  |
| 58   | HLFL          | 5.0           | 30            | 10                | 14   | 16   | 22   | 20                                | 25   |  |
| 60   | HL            | 10.0          | 51            | 3                 | 7    | 9    | 11   | 12                                | 17   |  |
| 62   | HML           | 10.0          | 52            | 6                 | 10   | 12   | 17   | 12                                | 22   |  |

### D-Duct Diffuser

| Page | Silencer Type | Face Velocity          | Self Noise Lw | DIL, dB at 250 Hz  |      | Pressure Drop in N/m <sup>2</sup> |  | Application   |
|------|---------------|------------------------|---------------|--------------------|------|-----------------------------------|--|---|
|      |               |                        |               | Pipe Diameter (mm) |      | Length (mm)                       |  |   |
|      |               | m/s                    | dB            | 700                | 1800 | All Sizes                         |  |   |
| 66   | DDS           | Fan Discharge Velocity | N/A           | 15                 | 18   | Static pressure regain diffuser   |  | Combination silencer and pressure regain diffuser to attenuate blade pass frequencies and minimise impact pressure losses on vane-axial or similar fan systems. |

### Ultra-Pals Packless Rectangular

| Page | Silencer Type | Face Velocity | Self Noise Lw | DIL, dB at 250 Hz |      |      | Pressure Drop in N/m <sup>2</sup> |     | Application   |
|------|---------------|---------------|---------------|-------------------|------|------|-----------------------------------|-----|---|
|      |               |               |               | Length (mm)       |      |      | Length (mm)                       |     |   |
|      |               | m/s           | dB            | 900               | 1800 | 2700 | All Sizes                         |     |   |
| 70   | XM            | 5.0           | 44            | 10                | 15   | 22   | 90                                | 149 | Ultra-clean, corrosive, flammable environments where the absence of any acoustic fill material is required such as hospitals, clean rooms, fuel facilities, pharmaceuticals and kitchens. Good low and high to mid frequency attenuation. |
| 72   | XL            | 5.0           | 44            | 17                | 23   | 29   | 119                               | 177 |   |
| 74   | KM            | 5.0           | 38            | 6                 | 10   | 15   | 27                                | 35  |   |
| 76   | KL            | 5.0           | 38            | 13                | 18   | 24   | 32                                | 45  |   |

### Ultra-Pals Packless Tubular

| Page | Silencer Type | Face Velocity | Self Noise Lw | DIL, dB at 250 Hz  |      | Pressure Drop in N/m <sup>2</sup> |  | Application  |
|------|---------------|---------------|---------------|--------------------|------|-----------------------------------|--|--|
|      |               |               |               | Pipe Diameter (mm) |      | Length (mm)                       |  |  |
|      |               | m/s           | dB            | 900                | 1900 | All Sizes                         |  |  |
| 78   | 200TXS        | 5.0           | 35            | 26                 | 37   | 16                                |  | Small diameter circular duct systems where the absence of any acoustic fill materials is required such as fume hoods, research facilities, food and dairy plants. Excellent broad band attenuation in 900mm lengths. |
| 78   | 300TXS        | 5.0           | 35            | 17                 | 35   | 15                                |  |  |
| 79   | 200TXL        | 5.0           | 28            | 25                 | 10   | 5                                 |  |  |
| 79   | 300TXL        | 5.0           | 28            | 16                 | 10   | 5                                 |  |  |
| 80   | 200TXLB       | 5.0           | 27            | 25                 | 22   | 22                                |  | TXLB' units are elbow orientation.   |
| 81   | 300TXLB       | 5.0           | 34            | 18                 | 22   | 22                                |  |  |

### Usage Example

Given a medium velocity rectangular duct system with a required DIL of approximately 30dB at 250 Hz. Consider a 5LFS, 7LFM, 7S or 7ES as possibly a good selection.

However, for complete silencer information refer to the individual silencer data pages in this guide.

# Specifications:

## Quiet-Duct® & Conic-Flow® Silencers

### General

Furnish and install Quiet-Duct® (rectangular) and Conic-Flow® (cylindrical) silencers of types and sizes shown on plans and/or listed in schedule. Silencers shall be the product of IAC Acoustics. Any change in this specification must be submitted in writing to and approved by the Architect/Engineer, at least 10 days prior to bid due-date.

### Materials and Construction

Outer casings of rectangular silencer modules shall be made of 22 gauge (0.8mm) galvanised steel in accordance with HVAC DW 144 recommended construction for high pressure rectangular duct-work. Seams shall be lock formed and mastic filled.

Outer casings of tubular silencer shall be made of galvanised steel in the following gauges.

| Types CS, CL, FCS, FCL, EC |             | Types NS, NL    |             |
|----------------------------|-------------|-----------------|-------------|
| Outside Dia, mm            | Metal Gauge | Outside Dia, mm | Metal Gauge |
| <750                       | 0.8mm       | 300-600         | 0.8mm       |
| 751-1200                   | 1.2mm       | 601-900         | 1.2mm       |
| >1201                      | 1.6mm       |                 |             |

Internal acoustic elements of rectangular silencers shall incorporate integral die formed easé entry and exit to minimise pressure drop and self-noise. Interior partitions for rectangular silencers shall be made of not less than 26 gauge (0.46mm)

galvanised perforated steel. Interior construction of tubular silencers shall be compatible with the outside casings. Filler material shall be of inorganic mineral or glass fibre of a density sufficient to obtain the specified acoustic performance and be packed under not less than 5% compression to eliminate voids due to vibration and settling. Materials shall be inert, vermin and moisture proof. (Specify suffix/GC model designation when encapsulation of infill using fibreglass cloth is required, e.g. clean or outdoor applications). Combustion rating for the silencer acoustic fill shall not be greater than the following when tested in accordance with ASTM E84, NFPA Standard 255 or UL No 723: Flamespread Classification – 20, Smoke Development Rating – 20. Airtight construction shall be provided by use of a duct sealing compound on the job site. Material and labour furnished by contractor. Silencers shall not fail structurally when subjected to a differential air pressure of 2000N/m<sup>2</sup> inside to outside of casing.

### Acoustic Performance

Silencer ratings shall be determined in a duct-to-reverberant room test facility which provides for airflow in both directions through the test silencer in accordance with applicable sections of ASTM E 477 and ISO 7235. The test set-up and procedure shall be such that all effects due to end reflection, directivity, flanking transmission, standing waves and test chamber sound absorption are eliminated. Acoustic ratings shall include Dynamic Insertion Loss (DIL) and Self-Noise (SN) Power Levels both for forward flow and reverse flow with airflow of at least 10m/s entering face velocity. Data for rectangular and tubular type silencers shall be presented for tests constructed using silencers no smaller than these cross-sections: Rectangular (mm): 600 x 600, 600 x 750 or 600 x 900, Tubular (mm): 300, 600, 900 & 1200.

## Aerodynamic Performance

Static pressure loss of silencers shall not exceed those listed in the silencer schedule as the airflow indicates. Airflow measurements shall be made in accordance with ASTM Specification E 477 and applicable portions of ASME, AMCA and ADC airflow test codes. Tests shall be reported on the identical units for which acoustic data is presented.

## Certification

With submittals, the manufacturer shall supply certified test data on Dynamic Insertion Loss, self-noise power levels, and aerodynamic performance for reverse and forward flow conditions. Test data shall be for a standard product. All rating tests shall be conducted in the same facility, utilise the same silencer, and be open to inspection upon request from the Architect/Engineer.

## Duct Transitions

When transitions are required to adapt silencer dimensions to connecting ductwork, they shall be furnished by the installing contractor.

## Flanges

Provide flanges as detailed in the same schedules if required.

## The Royal Opera House.

Various attenuators used within building.

# Quiet-Duct® Silencer Type: LFS

Superior Low Frequency Silencers with Forward and Reverse Flow Ratings

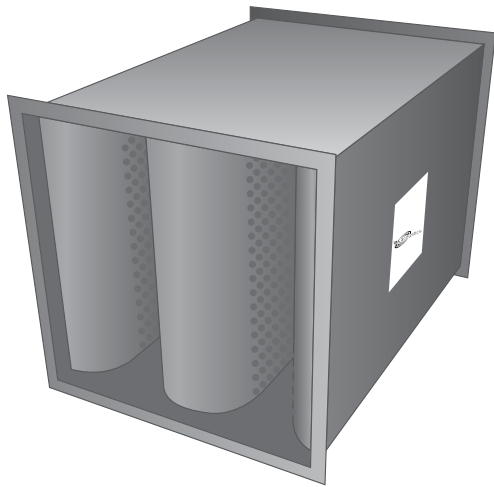

LFS silencers are advantageous where low frequency DIL requirements are high in HVAC systems. In some systems high frequency attenuation may be provided by the system components or may not be needed.

### Supplied as Standard

- Aerodynamic inlet and discharge to splitter elements to reduce pressure drop and conserve energy
- Perforated galvanised steel facings to all splitter elements to protect acoustic media from damage and erosion

### Designating Silencers (Example)

Model: 5LFS-600-600

| Length | Type | Width | Height |
|--------|------|-------|--------|
| 1500mm | LFS  | 600mm | 600mm  |

### Weight

Average weight 85kg/m<sup>3</sup>

## Self-Noise Power Levels dB re: 10<sup>-12</sup> Watts

| IAC LFS Model   | Octave Band                 | 1  | 2   | 3   | 4   | 5  | 6  | 7  | 8  |
|-----------------|-----------------------------|----|-----|-----|-----|----|----|----|----|
|                 | Hz                          | 63 | 125 | 250 | 500 | 1K | 2K | 4K | 8K |
| LFS All Lengths | Silencer Face Velocity, m/s |    |     |     |     |    |    |    |    |
|                 | -15                         | 58 | 54  | 58  | 61  | 62 | 63 | 65 | 63 |
|                 | -10                         | 51 | 49  | 53  | 56  | 56 | 59 | 60 | 53 |
|                 | -5                          | 45 | 42  | 45  | 43  | 45 | 49 | 44 | 37 |
|                 | +5                          | 46 | 42  | 45  | 43  | 45 | 49 | 44 | 37 |
|                 | +10                         | 56 | 54  | 57  | 56  | 52 | 56 | 57 | 51 |
|                 | +15                         | 68 | 64  | 65  | 66  | 61 | 61 | 64 | 61 |

## Aerodynamic Performance

| IAC Model                   | Length (mm) | Static Pressure Drop N/m <sup>2</sup> |      |      |      |      |      |      |      |
|-----------------------------|-------------|---------------------------------------|------|------|------|------|------|------|------|
| LFS                         | 900         | 10                                    | 12   | 17   | 22   | 27   | 35   | 42   | 50   |
|                             | 1500        | 10                                    | 15   | 20   | 25   | 32   | 40   | 47   | 55   |
|                             | 2100        | 10                                    | 15   | 20   | 25   | 33   | 40   | 50   | 57   |
|                             | 3000        | 10                                    | 15   | 22   | 27   | 35   | 45   | 52   | 65   |
| Silencer Face Velocity, m/s |             | 1.27                                  | 1.52 | 1.78 | 2.03 | 2.29 | 2.54 | 2.79 | 3.05 |

## Face Area Adjustment Factors (add or subtract from Lw values above)

|  |      |      |      |      |      |     |     |     |      |
|--|------|------|------|------|------|-----|-----|-----|------|
| Quiet-Duct® Face Area, m <sup>2*</sup> | 0.05 | 0.09 | 0.19 | 0.37 | 0.74 | 1.5 | 3.0 | 6.0 | 12.0 |
| Lw Adjustment Factor, dB               | -9   | -6   | -3   | 0    | +3   | +6  | +9  | +12 | +15  |

\* For intermediate face areas, interpolate to the nearest whole number



## Dynamic Insertion Loss (DIL) Ratings: Forward (+) / Reverse (-) Flow

| IAC LFS Model (length in mm) | Octave Band                 | 1  | 2   | 3   | 4   | 5  | 6  | 7  | 8  |
|------------------------------|-----------------------------|----|-----|-----|-----|----|----|----|----|
|                              | Hz                          | 63 | 125 | 250 | 500 | 1K | 2K | 4K | 8K |
|                              | Silencer Face Velocity, m/s |    |     |     |     |    |    |    |    |
| <b>3LFS (900)</b>            | -10                         | 8  | 14  | 25  | 29  | 27 | 20 | 16 | 12 |
|                              | -5                          | 7  | 13  | 23  | 28  | 26 | 20 | 16 | 14 |
|                              | 0                           | 8  | 13  | 23  | 28  | 27 | 21 | 17 | 14 |
|                              | +5                          | 9  | 12  | 22  | 28  | 27 | 21 | 18 | 14 |
|                              | +10                         | 7  | 11  | 21  | 25  | 25 | 21 | 17 | 14 |
| <b>4LFS (1200)</b>           | -10                         | 11 | 19  | 31  | 36  | 35 | 24 | 18 | 13 |
|                              | -5                          | 10 | 17  | 29  | 35  | 34 | 24 | 19 | 15 |
|                              | 0                           | 11 | 17  | 28  | 34  | 34 | 25 | 20 | 15 |
|                              | +5                          | 11 | 16  | 27  | 32  | 34 | 24 | 20 | 15 |
|                              | +10                         | 9  | 14  | 25  | 29  | 31 | 25 | 19 | 15 |
| <b>5LFS (1500)</b>           | -10                         | 13 | 23  | 36  | 42  | 42 | 28 | 19 | 14 |
|                              | -5                          | 13 | 21  | 35  | 41  | 41 | 28 | 21 | 15 |
|                              | 0                           | 13 | 20  | 33  | 39  | 41 | 28 | 22 | 16 |
|                              | +5                          | 12 | 19  | 31  | 36  | 40 | 27 | 22 | 16 |
|                              | +10                         | 10 | 17  | 28  | 33  | 37 | 29 | 20 | 16 |
| <b>6LFS (1800)</b>           | -10                         | 14 | 24  | 38  | 46  | 47 | 32 | 21 | 15 |
|                              | -5                          | 14 | 23  | 39  | 45  | 45 | 32 | 23 | 16 |
|                              | 0                           | 13 | 22  | 37  | 43  | 44 | 31 | 24 | 16 |
|                              | +5                          | 12 | 21  | 34  | 40  | 43 | 30 | 24 | 17 |
|                              | +10                         | 10 | 20  | 33  | 39  | 41 | 32 | 22 | 17 |
| <b>7LFS (2100)</b>           | -10                         | 14 | 25  | 40  | 50  | 51 | 35 | 22 | 16 |
|                              | -5                          | 14 | 24  | 42  | 49  | 49 | 35 | 24 | 17 |
|                              | 0                           | 13 | 24  | 40  | 47  | 47 | 34 | 25 | 17 |
|                              | +5                          | 12 | 23  | 37  | 44  | 45 | 33 | 25 | 17 |
|                              | +10                         | 10 | 22  | 37  | 44  | 45 | 34 | 24 | 17 |
| <b>8LFS (2400)</b>           | -10                         | 16 | 27  | 42  | 51  | 52 | 38 | 23 | 16 |
|                              | -5                          | 15 | 27  | 45  | 50  | 50 | 38 | 26 | 18 |
|                              | 0                           | 15 | 26  | 43  | 49  | 49 | 38 | 27 | 18 |
|                              | +5                          | 14 | 25  | 40  | 47  | 48 | 38 | 28 | 19 |
|                              | +10                         | 12 | 23  | 40  | 47  | 48 | 39 | 28 | 19 |
| <b>9LFS (2700)</b>           | -10                         | 17 | 28  | 44  | 51  | 52 | 40 | 24 | 17 |
|                              | -5                          | 17 | 29  | 47  | 51  | 52 | 42 | 27 | 18 |
|                              | 0                           | 16 | 28  | 46  | 50  | 51 | 42 | 30 | 20 |
|                              | +5                          | 15 | 26  | 44  | 49  | 50 | 42 | 32 | 21 |
|                              | +10                         | 14 | 24  | 43  | 50  | 50 | 43 | 32 | 22 |
| <b>10LFS (3000)</b>          | -10                         | 19 | 30  | 46  | 52  | 53 | 43 | 25 | 17 |
|                              | -5                          | 18 | 32  | 50  | 52  | 53 | 45 | 29 | 19 |
|                              | 0                           | 18 | 30  | 49  | 52  | 53 | 46 | 32 | 21 |
|                              | +5                          | 17 | 28  | 47  | 52  | 53 | 47 | 35 | 23 |
|                              | +10                         | 16 | 25  | 46  | 53  | 53 | 48 | 36 | 24 |

### Note

- Silencer Face Area is the cross-sectional area at the silencer entrance
- Face Velocity is the airflow (m<sup>3</sup>/s) divided by the Face Area (m<sup>2</sup>)
- Pressure drop for any face velocity can be calculated from the equation:  
 $PD = (\text{Actual FV} / \text{catalogue FV})^2 \times (\text{Catalogue PD})$
- Self Noise values shown are for a 0.37m<sup>2</sup> face area silencer
- For each doubling of face area add 3dB to the self noise values listed
- For each halving of face area subtract 3dB from the self noise values listed

# Quiet-Duct® Silencer Type: LFM

Low Frequency Silencers with Forward and Reverse Flow Ratings

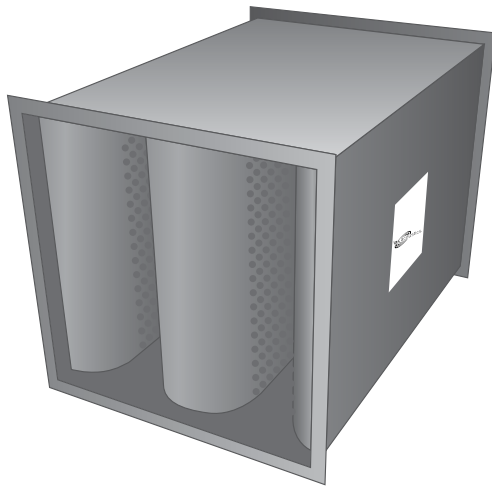

LFM silencers are advantageous where low frequency, particularly in the third and fourth octave bands; DIL requirements are high in HVAC systems. In some applications high frequency attenuation may be provided by the system components or may not be needed.

### Supplied as Standard

- Aerodynamic inlet and discharge to splitter elements to reduce pressure drop and conserve energy
- Perforated galvanised steel facings to all splitter elements to protect acoustic media from damage and erosion

### Designating Silencers: Example

Model: 5LFM-600-600

| Length | Type | Width | Height |
|--------|------|-------|--------|
| 1500mm | LFM  | 600mm | 600mm  |

### Weight

Average weight 80kg/m<sup>3</sup>

## Self-Noise Power Levels dB re: 10<sup>-12</sup> Watts

| IAC LFM Model   | Octave Band                 | 1  | 2   | 3   | 4   | 5  | 6  | 7  | 8  |
|-----------------|-----------------------------|----|-----|-----|-----|----|----|----|----|
|                 | Hz                          | 63 | 125 | 250 | 500 | 1K | 2K | 4K | 8K |
| LFM All Lengths | Silencer Face Velocity, m/s |    |     |     |     |    |    |    |    |
|                 | -15                         | 64 | 62  | 64  | 66  | 65 | 64 | 66 | 62 |
|                 | -10                         | 53 | 50  | 54  | 56  | 56 | 59 | 58 | 51 |
|                 | -5                          | 42 | 40  | 43  | 45  | 47 | 46 | 37 | 27 |
|                 | +5                          | 47 | 34  | 36  | 35  | 40 | 37 | 27 | 20 |
|                 | +10                         | 54 | 52  | 58  | 56  | 51 | 56 | 55 | 50 |
|                 | +15                         | 68 | 64  | 64  | 63  | 61 | 63 | 66 | 63 |

## Aerodynamic Performance

| IAC Model                   | Length (mm) | Static Pressure Drop N/m <sup>2</sup> |      |      |      |      |      |      |     |
|-----------------------------|-------------|---------------------------------------|------|------|------|------|------|------|-----|
| LFM                         | 900         | 12                                    | 17   | 22   | 30   | 37   | 47   | 57   | 67  |
|                             | 1500        | 12                                    | 17   | 25   | 32   | 40   | 50   | 60   | 72  |
|                             | 2100        | 12                                    | 17   | 25   | 32   | 42   | 52   | 62   | 75  |
|                             | 3000        | 12                                    | 20   | 30   | 37   | 47   | 60   | 72   | 85  |
| Silencer Face Velocity, m/s |             | 2.54                                  | 3.05 | 3.56 | 4.06 | 4.57 | 5.08 | 5.59 | 6.1 |

## Face Area Adjustment Factors (add or subtract from Lw values above)

| Quiet-Duct® Face Area, m <sup>2</sup> * | 0.05 | 0.09 | 0.19 | 0.37 | 0.74 | 1.5 | 3.0 | 6.0 | 12.0 |
|---|------|------|------|------|------|-----|-----|-----|------|
| Lw Adjustment Factor, dB                | -9   | -6   | -3   | 0    | +3   | +6  | +9  | +12 | +15  |

\* For intermediate face areas, interpolate to the nearest whole number

## Dynamic Insertion Loss (DIL) Ratings: Forward (+) / Reverse (-) Flow

| IAC LFM Model (length in mm) | Octave Band                 | 1  | 2   | 3   | 4   | 5  | 6  | 7  | 8  |
|------------------------------|-----------------------------|----|-----|-----|-----|----|----|----|----|
|                              | Hz                          | 63 | 125 | 250 | 500 | 1K | 2K | 4K | 8K |
|                              | Silencer Face Velocity, m/s |    |     |     |     |    |    |    |    |
| <b>3LFM (900)</b>            | -10                         | 6  | 9   | 17  | 22  | 19 | 14 | 12 | 10 |
|                              | -5                          | 6  | 8   | 16  | 21  | 18 | 13 | 12 | 11 |
|                              | 0                           | 5  | 8   | 16  | 21  | 18 | 13 | 12 | 11 |
|                              | 5                           | 4  | 7   | 15  | 20  | 17 | 13 | 11 | 10 |
|                              | 10                          | 4  | 7   | 14  | 19  | 17 | 12 | 11 | 10 |
| <b>4LFM (1200)</b>           | -10                         | 8  | 13  | 22  | 27  | 24 | 16 | 13 | 12 |
|                              | -5                          | 8  | 12  | 21  | 26  | 24 | 15 | 14 | 12 |
|                              | 0                           | 7  | 11  | 21  | 26  | 24 | 15 | 14 | 12 |
|                              | 5                           | 6  | 10  | 19  | 25  | 23 | 15 | 13 | 12 |
|                              | 10                          | 6  | 10  | 18  | 24  | 23 | 15 | 13 | 11 |
| <b>5LFM (1500)</b>           | -10                         | 9  | 16  | 26  | 32  | 29 | 17 | 13 | 13 |
|                              | -5                          | 9  | 15  | 26  | 31  | 30 | 17 | 15 | 13 |
|                              | 0                           | 9  | 14  | 25  | 30  | 29 | 17 | 15 | 13 |
|                              | 5                           | 8  | 13  | 23  | 29  | 28 | 17 | 14 | 13 |
|                              | 10                          | 7  | 12  | 22  | 28  | 28 | 17 | 14 | 12 |
| <b>6LFM (1800)</b>           | -10                         | 11 | 17  | 29  | 38  | 34 | 19 | 15 | 14 |
|                              | -5                          | 11 | 17  | 29  | 37  | 35 | 19 | 17 | 14 |
|                              | 0                           | 11 | 16  | 28  | 36  | 34 | 20 | 17 | 14 |
|                              | 5                           | 10 | 15  | 27  | 35  | 33 | 20 | 16 | 14 |
|                              | 10                          | 9  | 14  | 25  | 34  | 33 | 20 | 16 | 14 |
| <b>7LFM (2100)</b>           | -10                         | 12 | 18  | 32  | 44  | 39 | 21 | 16 | 14 |
|                              | -5                          | 12 | 18  | 32  | 43  | 39 | 21 | 18 | 15 |
|                              | 0                           | 12 | 17  | 31  | 42  | 39 | 22 | 18 | 15 |
|                              | 5                           | 12 | 16  | 30  | 41  | 38 | 22 | 17 | 14 |
|                              | 10                          | 11 | 15  | 28  | 39  | 38 | 23 | 17 | 15 |
| <b>8LFM (2400)</b>           | -10                         | 13 | 20  | 35  | 46  | 43 | 23 | 17 | 15 |
|                              | -5                          | 13 | 20  | 35  | 46  | 43 | 23 | 19 | 16 |
|                              | 0                           | 13 | 19  | 34  | 45  | 43 | 24 | 19 | 16 |
|                              | 5                           | 13 | 18  | 33  | 44  | 42 | 24 | 18 | 15 |
|                              | 10                          | 12 | 17  | 31  | 43  | 42 | 25 | 19 | 16 |
| <b>9LFM (2700)</b>           | -10                         | 15 | 22  | 38  | 49  | 47 | 24 | 19 | 15 |
|                              | -5                          | 15 | 22  | 39  | 48  | 46 | 25 | 21 | 16 |
|                              | 0                           | 15 | 21  | 38  | 48  | 46 | 26 | 21 | 16 |
|                              | 5                           | 14 | 20  | 36  | 47  | 46 | 26 | 20 | 15 |
|                              | 10                          | 13 | 18  | 35  | 46  | 46 | 26 | 20 | 16 |
| <b>10LFM (3000)</b>          | -10                         | 16 | 24  | 41  | 51  | 51 | 26 | 20 | 16 |
|                              | -5                          | 16 | 24  | 42  | 51  | 50 | 27 | 22 | 17 |
|                              | 0                           | 16 | 23  | 41  | 51  | 50 | 28 | 22 | 17 |
|                              | 5                           | 15 | 22  | 39  | 50  | 50 | 28 | 21 | 16 |
|                              | 10                          | 14 | 20  | 38  | 50  | 50 | 28 | 22 | 17 |

### Note

- Silencer Face Area is the cross-sectional area at the silencer entrance
- Face Velocity is the airflow (m<sup>3</sup>/s) divided by the Face Area (m<sup>2</sup>)
- Pressure drop for any face velocity can be calculated from the equation:  
 $PD = (\text{Actual FV} / \text{catalogue FV})^2 \times (\text{Catalogue PD})$
- Self Noise values shown are for a 0.37m<sup>2</sup> face area silencer
- For each doubling of face area add 3dB to the self noise values listed
- For each halving of face area subtract 3dB from the self noise values listed

# Quiet-Duct® Silencer Type: S

With Forward and Reverse Flow Ratings

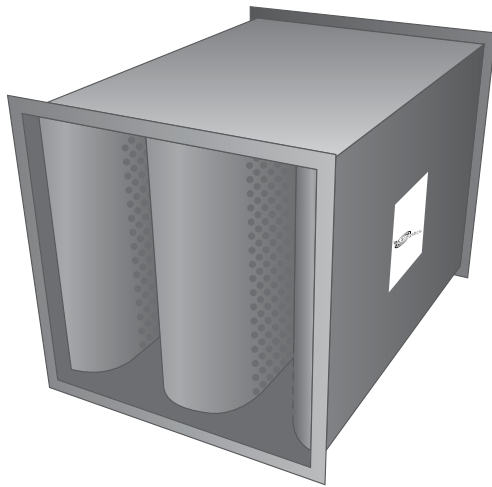

## Supplied as Standard

- Aerodynamic inlet and discharge to splitter elements to reduce pressure drop and conserve energy
- Perforated galvanised steel facings to all splitter elements to protect acoustic media from damage and erosion

## Designating Silencers: Example

Model: 5S-600-600

| Length | Type | Width | Height |
|--------|------|-------|--------|
| 1500mm | S    | 600mm | 600mm  |

## Weight

Average weight 100kg/m<sup>3</sup>

## Self-Noise Power Levels dB re: 10<sup>-12</sup> Watts

| IAC S Model   | Octave Band                 | 1  | 2   | 3   | 4   | 5  | 6  | 7  | 8  |
|---------------|-----------------------------|----|-----|-----|-----|----|----|----|----|
|               | Hz                          | 63 | 125 | 250 | 500 | 1K | 2K | 4K | 8K |
|               | Silencer Face Velocity, m/s |    |     |     |     |    |    |    |    |
| S All Lengths | -15                         | 68 | 62  | 61  | 66  | 61 | 64 | 67 | 66 |
|               | -10                         | 54 | 51  | 50  | 51  | 54 | 56 | 52 | 40 |
|               | -5                          | 40 | 40  | 39  | 36  | 47 | 48 | 37 | 20 |
|               | +5                          | 36 | 29  | 35  | 30  | 31 | 35 | 22 | 20 |
|               | +10                         | 55 | 49  | 49  | 47  | 46 | 49 | 42 | 32 |
|               | +15                         | 74 | 69  | 63  | 64  | 61 | 63 | 62 | 56 |

## Aerodynamic Performance

| IAC Model                   | Length (mm) | Static Pressure Drop N/m <sup>2</sup> |      |      |      |      |      |      |      |
|-----------------------------|-------------|---------------------------------------|------|------|------|------|------|------|------|
|                             |             | 1                                     | 2    | 3    | 4    | 5    | 6    | 7    | 8    |
| S                           | 900         | 2                                     | 7    | 15   | 22   | 32   | 45   | 57   | 72   |
|                             | 1500        | 5                                     | 10   | 17   | 25   | 37   | 50   | 65   | 82   |
|                             | 2100        | 5                                     | 10   | 17   | 27   | 40   | 52   | 70   | 87   |
|                             | 3000        | 5                                     | 10   | 20   | 30   | 45   | 60   | 80   | 100  |
| Silencer Face Velocity, m/s |             | 1.02                                  | 1.52 | 2.03 | 2.54 | 3.05 | 3.56 | 4.06 | 4.57 |

## Face Area Adjustment Factors (add or subtract from Lw values above)

|   |      |      |      |      |      |     |     |     |      |
|---|------|------|------|------|------|-----|-----|-----|------|
| Quiet-Duct® Face Area, m <sup>2</sup> * | 0.05 | 0.09 | 0.19 | 0.37 | 0.76 | 1.5 | 3.0 | 6.0 | 12.0 |
| Lw Adjustment Factor, dB                | -9   | -6   | -3   | 0    | +3   | +6  | +9  | +12 | +15  |

\* For intermediate face areas, interpolate to the nearest whole number

## Dynamic Insertion Loss (DIL) Ratings: Forward (+) / Reverse (-) Flow

| IAC S Model (length in mm) | Octave Band                 | 1  | 2   | 3   | 4   | 5  | 6  | 7  | 8  |
|----------------------------|-----------------------------|----|-----|-----|-----|----|----|----|----|
|                            | Hz                          | 63 | 125 | 250 | 500 | 1K | 2K | 4K | 8K |
|                            | Silencer Face Velocity, m/s |    |     |     |     |    |    |    |    |
| <b>3S (900)</b>            | -10                         | 6  | 12  | 20  | 33  | 39 | 35 | 23 | 14 |
|                            | -5                          | 5  | 11  | 17  | 33  | 38 | 35 | 25 | 14 |
|                            | 0                           | 5  | 10  | 16  | 32  | 38 | 35 | 26 | 16 |
|                            | +5                          | 5  | 9   | 15  | 30  | 37 | 35 | 27 | 17 |
|                            | +10                         | 5  | 8   | 14  | 27  | 36 | 35 | 27 | 17 |
| <b>4S (1200)</b>           | -10                         | 8  | 16  | 24  | 35  | 44 | 39 | 30 | 18 |
|                            | -5                          | 8  | 15  | 22  | 39  | 43 | 40 | 32 | 18 |
|                            | 0                           | 7  | 14  | 21  | 38  | 43 | 41 | 33 | 20 |
|                            | +5                          | 6  | 13  | 19  | 36  | 42 | 41 | 34 | 21 |
|                            | +10                         | 6  | 12  | 18  | 34  | 41 | 41 | 34 | 21 |
| <b>5S (1500)</b>           | -10                         | 10 | 20  | 27  | 45  | 48 | 43 | 36 | 22 |
|                            | -5                          | 10 | 19  | 26  | 44  | 47 | 45 | 38 | 22 |
|                            | 0                           | 9  | 17  | 25  | 43  | 47 | 46 | 39 | 24 |
|                            | +5                          | 7  | 17  | 23  | 42  | 46 | 46 | 40 | 25 |
|                            | +10                         | 6  | 16  | 22  | 40  | 46 | 46 | 40 | 25 |
| <b>6S (1800)</b>           | -10                         | 11 | 22  | 32  | 47  | 49 | 44 | 39 | 25 |
|                            | -5                          | 11 | 21  | 31  | 46  | 48 | 46 | 41 | 25 |
|                            | 0                           | 10 | 19  | 29  | 45  | 48 | 47 | 42 | 28 |
|                            | +5                          | 8  | 18  | 27  | 45  | 48 | 47 | 43 | 30 |
|                            | +10                         | 7  | 16  | 27  | 43  | 48 | 47 | 43 | 30 |
| <b>7S (2100)</b>           | -10                         | 12 | 23  | 37  | 48  | 50 | 45 | 41 | 27 |
|                            | -5                          | 12 | 22  | 35  | 47  | 49 | 47 | 44 | 28 |
|                            | 0                           | 11 | 20  | 33  | 47  | 49 | 47 | 45 | 31 |
|                            | +5                          | 9  | 18  | 31  | 47  | 49 | 47 | 45 | 34 |
|                            | +10                         | 8  | 16  | 31  | 46  | 49 | 48 | 45 | 35 |
| <b>8S (2400)</b>           | -10                         | 13 | 24  | 39  | 49  | 50 | 47 | 42 | 30 |
|                            | -5                          | 13 | 24  | 37  | 48  | 50 | 48 | 46 | 31 |
|                            | 0                           | 12 | 22  | 36  | 48  | 48 | 48 | 46 | 34 |
|                            | +5                          | 10 | 19  | 34  | 48  | 50 | 48 | 46 | 37 |
|                            | +10                         | 9  | 17  | 34  | 47  | 50 | 49 | 46 | 39 |
| <b>9S (2700)</b>           | -10                         | 13 | 25  | 41  | 49  | 51 | 48 | 44 | 34 |
|                            | -5                          | 13 | 26  | 40  | 48  | 50 | 49 | 47 | 34 |
|                            | 0                           | 12 | 23  | 39  | 48  | 51 | 49 | 48 | 38 |
|                            | +5                          | 11 | 21  | 38  | 48  | 51 | 49 | 48 | 41 |
|                            | +10                         | 10 | 18  | 37  | 49  | 51 | 49 | 48 | 42 |
| <b>10S (3000)</b>          | -10                         | 14 | 26  | 43  | 50  | 51 | 50 | 45 | 37 |
|                            | -5                          | 14 | 28  | 42  | 49  | 51 | 50 | 49 | 37 |
|                            | 0                           | 13 | 25  | 42  | 49  | 52 | 50 | 49 | 41 |
|                            | +5                          | 12 | 22  | 41  | 49  | 52 | 50 | 49 | 44 |
|                            | +10                         | 11 | 19  | 40  | 50  | 52 | 50 | 49 | 46 |

### Note

- Silencer Face Area is the cross-sectional area at the silencer entrance
- Face Velocity is the airflow (m<sup>3</sup>/s) divided by the Face Area (m<sup>2</sup>)
- Pressure drop for any face velocity can be calculated from the equation:  
 $PD = (\text{Actual FV} / \text{catalogue FV})^2 \times (\text{Catalogue PD})$
- Self Noise values shown are for a 0.37m<sup>2</sup> face area silencer
- For each doubling of face area add 3dB to the self noise values listed
- For each halving of face area subtract 3dB from the self noise values listed

# Quiet-Duct® Silencer Type: SM

With Forward and Reverse Flow

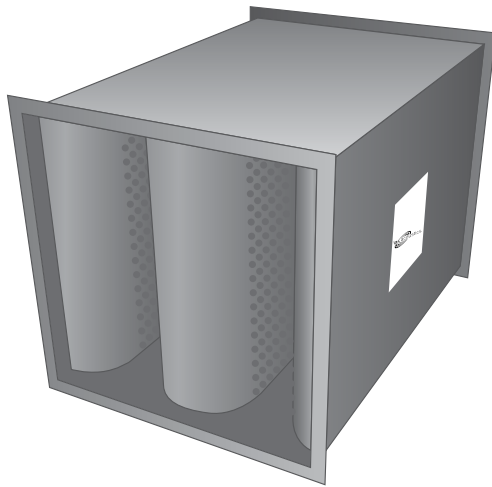

### Supplied as Standard

- Aerodynamic inlet and discharge to splitter elements to reduce pressure drop and conserve energy
- Perforated galvanised steel facings to all splitter elements to protect acoustic media from damage and erosion

### Designating Silencers: Example

Model: 5SM-660-600

| Length | Type | Width | Height |
|--------|------|-------|--------|
| 1500mm | SM   | 660mm | 600mm  |

### Weight

Average weight 95kg/m<sup>3</sup>

## Self-Noise Power Levels dB re: 10<sup>-12</sup> Watts

| IAC SM Model   | Octave Band                 | 1  | 2   | 3   | 4   | 5  | 6  | 7   | 8   |
|----------------|-----------------------------|----|-----|-----|-----|----|----|-----|-----|
|                | Hz                          | 63 | 125 | 250 | 500 | 1K | 2K | 4K  | 8K  |
|                | Silencer Face Velocity, m/s |    |     |     |     |    |    |     |     |
| SM All Lengths | -15                         | 66 | 61  | 60  | 64  | 61 | 63 | 65  | 61  |
|                | -10                         | 52 | 50  | 49  | 49  | 54 | 55 | 50  | 35  |
|                | -5                          | 68 | 39  | 38  | 34  | 47 | 47 | 35  | <20 |
|                | +5                          | 33 | 24  | 31  | 27  | 27 | 30 | <20 | <20 |
|                | +10                         | 52 | 44  | 46  | 44  | 42 | 44 | 39  | 29  |
|                | +15                         | 71 | 65  | 60  | 60  | 57 | 59 | 58  | 53  |

## Aerodynamic Performance

| IAC Model                   | Length (mm) | Static Pressure Drop N/m <sup>2</sup> |      |      |      |      |      |      |      |
|-----------------------------|-------------|---------------------------------------|------|------|------|------|------|------|------|
|                             |             | 1                                     | 2    | 3    | 4    | 5    | 6    | 7    | 8    |
| SM                          | 900         | 8                                     | 13   | 19   | 25   | 33   | 42   | 52   | 63   |
|                             | 1500        | 10                                    | 15   | 22   | 29   | 39   | 49   | 60   | 73   |
|                             | 2100        | 11                                    | 17   | 25   | 34   | 44   | 56   | 69   | 99   |
|                             | 3000        | 13                                    | 20   | 29   | 40   | 52   | 65   | 81   | 116  |
| Silencer Face Velocity, m/s |             | 2.03                                  | 2.54 | 3.05 | 3.56 | 4.06 | 4.57 | 5.08 | 5.59 |

## Face Area Adjustment Factors (add or subtract from Lw values above)

|   |      |     |     |     |     |     |     |     |      |
|---|------|-----|-----|-----|-----|-----|-----|-----|------|
| Quiet-Duct® Face Area, m <sup>2</sup> * | 0.05 | 0.1 | 0.2 | 0.4 | 0.8 | 1.6 | 3.2 | 6.4 | 12.8 |
| Lw Adjustment Factor, dB                | -9   | -6  | -3  | 0   | +3  | +6  | +9  | +12 | +15  |

\* For intermediate face areas, interpolate to the nearest whole number

## Dynamic Insertion Loss (DIL) Ratings: Forward (+) / Reverse (-) Flow

| IAC SM Model (length in mm) | Octave Band                 | 1  | 2   | 3   | 4   | 5  | 6  | 7  | 8  |
|-----------------------------|-----------------------------|----|-----|-----|-----|----|----|----|----|
|                             | Hz                          | 63 | 125 | 250 | 500 | 1K | 2K | 4K | 8K |
|                             | Silencer Face Velocity, m/s |    |     |     |     |    |    |    |    |
| <b>3SM (900)</b>            | -10                         | 6  | 10  | 18  | 30  | 35 | 30 | 20 | 12 |
|                             | -5                          | 5  | 10  | 16  | 30  | 34 | 30 | 21 | 13 |
|                             | 0                           | 5  | 9   | 15  | 29  | 34 | 30 | 22 | 14 |
|                             | 5                           | 5  | 8   | 14  | 27  | 33 | 30 | 23 | 15 |
|                             | 10                          | 5  | 7   | 13  | 25  | 32 | 30 | 23 | 15 |
| <b>4SM (1200)</b>           | -10                         | 7  | 14  | 21  | 36  | 41 | 35 | 25 | 15 |
|                             | -5                          | 7  | 13  | 20  | 36  | 40 | 36 | 27 | 16 |
|                             | 0                           | 7  | 12  | 19  | 35  | 40 | 36 | 28 | 17 |
|                             | 5                           | 6  | 12  | 18  | 34  | 39 | 36 | 29 | 18 |
|                             | 10                          | 5  | 11  | 17  | 32  | 39 | 36 | 29 | 18 |
| <b>5SM (1500)</b>           | -10                         | 8  | 17  | 24  | 42  | 46 | 39 | 30 | 18 |
|                             | -5                          | 8  | 16  | 24  | 41  | 46 | 41 | 32 | 18 |
|                             | 0                           | 8  | 15  | 23  | 40  | 46 | 41 | 33 | 20 |
|                             | 5                           | 6  | 15  | 21  | 40  | 45 | 42 | 34 | 21 |
|                             | 10                          | 5  | 14  | 20  | 38  | 45 | 42 | 34 | 21 |
| <b>6SM (1800)</b>           | -10                         | 9  | 19  | 29  | 44  | 48 | 41 | 33 | 20 |
|                             | -5                          | 9  | 18  | 28  | 43  | 48 | 43 | 35 | 21 |
|                             | 0                           | 9  | 17  | 27  | 43  | 48 | 43 | 36 | 23 |
|                             | 5                           | 7  | 16  | 25  | 43  | 47 | 44 | 37 | 25 |
|                             | 10                          | 7  | 15  | 24  | 41  | 47 | 45 | 37 | 25 |
| <b>7SM (2100)</b>           | -10                         | 10 | 20  | 33  | 46  | 50 | 43 | 35 | 22 |
|                             | -5                          | 10 | 19  | 32  | 45  | 49 | 45 | 38 | 23 |
|                             | 0                           | 10 | 18  | 30  | 45  | 49 | 45 | 39 | 26 |
|                             | 5                           | 8  | 17  | 29  | 45  | 49 | 46 | 39 | 28 |
|                             | 10                          | 8  | 15  | 28  | 44  | 49 | 47 | 39 | 29 |
| <b>8SM (2400)</b>           | -10                         | 11 | 21  | 35  | 47  | 50 | 45 | 37 | 25 |
|                             | -5                          | 11 | 21  | 34  | 46  | 50 | 47 | 40 | 26 |
|                             | 0                           | 11 | 20  | 33  | 46  | 50 | 47 | 41 | 29 |
|                             | 5                           | 9  | 18  | 32  | 46  | 50 | 48 | 41 | 31 |
|                             | 10                          | 9  | 16  | 31  | 45  | 50 | 48 | 41 | 32 |
| <b>9SM (2700)</b>           | -10                         | 12 | 23  | 38  | 47  | 51 | 48 | 39 | 27 |
|                             | -5                          | 12 | 23  | 37  | 47  | 50 | 48 | 42 | 28 |
|                             | 0                           | 11 | 21  | 36  | 47  | 51 | 48 | 43 | 31 |
|                             | 5                           | 11 | 20  | 35  | 47  | 51 | 49 | 43 | 33 |
|                             | 10                          | 10 | 17  | 34  | 47  | 51 | 50 | 43 | 35 |
| <b>10SM (3000)</b>          | -10                         | 13 | 24  | 40  | 48  | 51 | 50 | 41 | 30 |
|                             | -5                          | 13 | 25  | 39  | 48  | 51 | 50 | 44 | 31 |
|                             | 0                           | 12 | 23  | 39  | 48  | 52 | 50 | 45 | 34 |
|                             | 5                           | 12 | 21  | 38  | 48  | 52 | 51 | 45 | 36 |
|                             | 10                          | 11 | 18  | 37  | 48  | 52 | 51 | 45 | 38 |

### Note

- Silencer Face Area is the cross-sectional area at the silencer entrance
- Face Velocity is the airflow (m<sup>3</sup>/s) divided by the Face Area (m<sup>2</sup>)
- Pressure drop for any face velocity can be calculated from the equation:  
 $PD = (\text{Actual FV} / \text{catalogue FV})^2 \times (\text{Catalogue PD})$
- Self Noise values shown are for a 0.4m<sup>2</sup> face area silencer
- For each doubling of face area add 3dB to the self noise values listed
- For each halving of face area subtract 3dB from the self noise values listed

# Quiet-Duct® Silencer Type: ES

With Forward and Reverse Flow Ratings

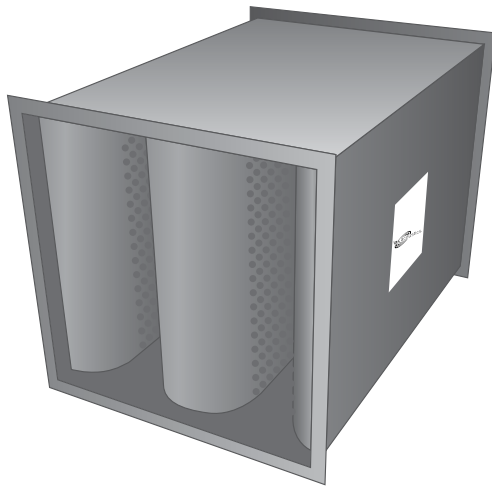

For many years, the IAC S silencer has been the industry standard for maximum noise reduction with minimum silencer length. The type ES (Energy Saver) silencer provides the same high level of acoustic performance combined with a marked decrease in energy consumption.

### Supplied as Standard

- Aerodynamic inlet and discharge to splitter elements to reduce pressure drop and conserve energy
- Perforated galvanised steel facings to all splitter elements to protect acoustic media from damage and erosion

### Designating Silencers: Example

Model: 5ES-600-600

| Length | Type | Width | Height |
|--------|------|-------|--------|
| 1500mm | ES   | 600mm | 600mm  |

### Weight

Average weight 100kg/m<sup>3</sup>

## Self-Noise Power Levels dB re: 10<sup>-12</sup> Watts

| IAC ES Model   | Octave Band                 | 1  | 2   | 3   | 4   | 5  | 6  | 7  | 8  |
|----------------|-----------------------------|----|-----|-----|-----|----|----|----|----|
|                | Hz                          | 63 | 125 | 250 | 500 | 1K | 2K | 4K | 8K |
|                | Silencer Face Velocity, m/s |    |     |     |     |    |    |    |    |
| ES All Lengths | -15                         | 56 | 54  | 58  | 60  | 61 | 65 | 69 | 64 |
|                | -10                         | 47 | 47  | 52  | 55  | 57 | 63 | 64 | 54 |
|                | -5                          | 41 | 41  | 45  | 47  | 52 | 60 | 48 | 38 |
|                | +5                          | 42 | 35  | 33  | 32  | 34 | 33 | 27 | 22 |
|                | +10                         | 50 | 47  | 44  | 41  | 43 | 45 | 43 | 41 |
|                | +15                         | 60 | 57  | 54  | 50  | 49 | 53 | 53 | 50 |

## Aerodynamic Performance

| IAC Model                   | Length (mm) | Static Pressure Drop N/m <sup>2</sup> |      |      |      |      |      |      |      |
|-----------------------------|-------------|---------------------------------------|------|------|------|------|------|------|------|
|                             |             | 1.02                                  | 1.52 | 2.03 | 2.54 | 3.05 | 3.56 | 4.06 | 4.57 |
| ES                          | 900         | 2                                     | 5    | 10   | 15   | 20   | 27   | 35   | 45   |
|                             | 1500        | 2                                     | 5    | 10   | 15   | 22   | 30   | 37   | 47   |
|                             | 2100        | 2                                     | 7    | 12   | 20   | 30   | 42   | 55   | 70   |
|                             | 3000        | 5                                     | 10   | 17   | 27   | 40   | 55   | 70   | 90   |
| Silencer Face Velocity, m/s |             | 1.02                                  | 1.52 | 2.03 | 2.54 | 3.05 | 3.56 | 4.06 | 4.57 |

## Face Area Adjustment Factors (add or subtract from Lw values above)

| Quiet-Duct® Face Area, m <sup>2</sup> * | 0.05 | 0.09 | 0.19 | 0.37 | 0.76 | 1.5 | 3.0 | 6.0 | 12.0 |
|---|------|------|------|------|------|-----|-----|-----|------|
| Lw Adjustment Factor, dB                | -9   | -6   | -3   | 0    | +3   | +6  | +9  | +12 | +15  |

\* For intermediate face areas, interpolate to the nearest whole number



## Dynamic Insertion Loss (DIL) Ratings: Forward (+) / Reverse (-) Flow

| IAC ES Model (length in mm) | Octave Band                 | 1  | 2   | 3   | 4   | 5  | 6  | 7  | 8  |
|-----------------------------|-----------------------------|----|-----|-----|-----|----|----|----|----|
|                             | Hz                          | 63 | 125 | 250 | 500 | 1K | 2K | 4K | 8K |
|                             | Silencer Face Velocity, m/s |    |     |     |     |    |    |    |    |
| <b>3ES (900)</b>            | -10                         | 5  | 8   | 18  | 31  | 38 | 36 | 22 | 16 |
|                             | -5                          | 3  | 8   | 17  | 31  | 38 | 36 | 22 | 17 |
|                             | 0                           | 3  | 6   | 16  | 29  | 38 | 35 | 22 | 18 |
|                             | +5                          | 2  | 5   | 14  | 27  | 36 | 34 | 23 | 17 |
|                             | +10                         | 2  | 5   | 12  | 25  | 34 | 34 | 23 | 18 |
| <b>4ES (1200)</b>           | -10                         | 8  | 12  | 22  | 36  | 45 | 42 | 24 | 17 |
|                             | -5                          | 7  | 12  | 21  | 36  | 44 | 43 | 27 | 19 |
|                             | 0                           | 6  | 9   | 19  | 34  | 44 | 43 | 27 | 19 |
|                             | +5                          | 5  | 9   | 17  | 32  | 44 | 42 | 29 | 20 |
|                             | +10                         | 4  | 9   | 16  | 30  | 42 | 42 | 29 | 21 |
| <b>5ES (1500)</b>           | -10                         | 10 | 16  | 25  | 41  | 52 | 48 | 26 | 17 |
|                             | -5                          | 10 | 15  | 24  | 40  | 50 | 50 | 31 | 20 |
|                             | 0                           | 9  | 12  | 22  | 38  | 51 | 50 | 33 | 22 |
|                             | +5                          | 7  | 12  | 19  | 37  | 51 | 49 | 35 | 23 |
|                             | +10                         | 6  | 12  | 19  | 35  | 49 | 49 | 35 | 24 |
| <b>6ES (1800)</b>           | -10                         | 11 | 18  | 32  | 47  | 52 | 51 | 32 | 19 |
|                             | -5                          | 11 | 18  | 30  | 46  | 52 | 52 | 37 | 23 |
|                             | 0                           | 10 | 16  | 28  | 44  | 52 | 52 | 40 | 26 |
|                             | +5                          | 7  | 14  | 25  | 44  | 52 | 51 | 41 | 28 |
|                             | +10                         | 6  | 14  | 24  | 42  | 52 | 50 | 42 | 29 |
| <b>7ES (2100)</b>           | -10                         | 11 | 20  | 39  | 53  | 51 | 53 | 37 | 21 |
|                             | -5                          | 11 | 21  | 36  | 51  | 53 | 53 | 43 | 25 |
|                             | 0                           | 10 | 19  | 33  | 50  | 53 | 53 | 46 | 29 |
|                             | +5                          | 7  | 16  | 31  | 50  | 53 | 52 | 46 | 32 |
|                             | +10                         | 6  | 15  | 29  | 48  | 54 | 50 | 48 | 34 |
| <b>8ES (2400)</b>           | -10                         | 12 | 24  | 39  | 53  | 52 | 53 | 39 | 22 |
|                             | -5                          | 12 | 25  | 39  | 51  | 52 | 53 | 45 | 25 |
|                             | 0                           | 10 | 22  | 36  | 51  | 53 | 53 | 47 | 31 |
|                             | +5                          | 8  | 19  | 34  | 51  | 52 | 53 | 47 | 34 |
|                             | +10                         | 6  | 18  | 32  | 50  | 53 | 51 | 49 | 36 |
| <b>9ES (2700)</b>           | -10                         | 14 | 27  | 40  | 53  | 53 | 53 | 41 | 23 |
|                             | -5                          | 12 | 29  | 41  | 51  | 52 | 53 | 46 | 26 |
|                             | 0                           | 11 | 25  | 40  | 51  | 52 | 53 | 48 | 31 |
|                             | +5                          | 8  | 22  | 38  | 51  | 52 | 53 | 48 | 35 |
|                             | +10                         | 7  | 21  | 35  | 51  | 52 | 53 | 49 | 37 |
| <b>10ES (3000)</b>          | -10                         | 15 | 31  | 40  | 53  | 54 | 53 | 43 | 24 |
|                             | -5                          | 13 | 33  | 44  | 51  | 51 | 53 | 48 | 26 |
|                             | 0                           | 11 | 28  | 43  | 52  | 52 | 53 | 49 | 32 |
|                             | +5                          | 9  | 25  | 41  | 52  | 51 | 54 | 49 | 37 |
|                             | +10                         | 7  | 24  | 38  | 53  | 51 | 54 | 50 | 39 |

### Note

- Silencer Face Area is the cross-sectional area at the silencer entrance
- Face Velocity is the airflow (m<sup>3</sup>/s) divided by the Face Area (m<sup>2</sup>)
- Pressure drop for any face velocity can be calculated from the equation:  
 $PD = (\text{Actual FV} / \text{catalogue FV})^2 \times (\text{Catalogue PD})$
- Self Noise values shown are for a 0.37m<sup>2</sup> face area silencer
- For each doubling of face area add 3dB to the self noise values listed
- For each halving of face area subtract 3dB from the self noise values listed

# Quiet-Duct® Silencer Type: MS

With Forward and Reverse Flow Ratings

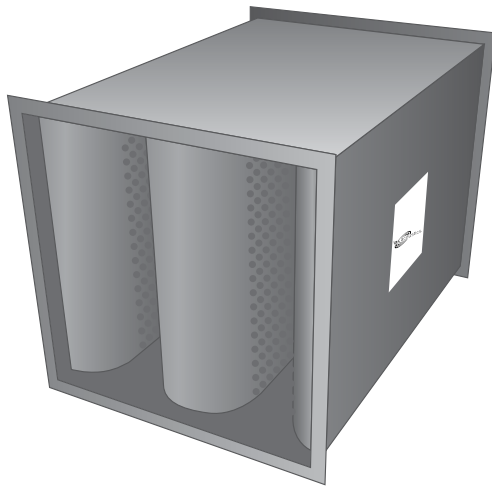

## Supplied as Standard

- Aerodynamic inlet and discharge to splitter elements to reduce pressure drop and conserve energy
- Perforated galvanised steel facings to all splitter elements to protect acoustic media from damage and erosion

## Designating Silencers: Example

Model: 5MS-750-600

| Length | Type | Width | Height |
|--------|------|-------|--------|
| 1500mm | MS   | 750mm | 600mm  |

## Weight

Average weight 85kg/m<sup>3</sup>

## Self-Noise Power Levels dB re: 10<sup>-12</sup> Watts

| IAC MS Model   | Octave Band                 | 1  | 2   | 3   | 4   | 5  | 6  | 7  | 8  |
|----------------|-----------------------------|----|-----|-----|-----|----|----|----|----|
|                | Hz                          | 63 | 125 | 250 | 500 | 1K | 2K | 4K | 8K |
|                | Silencer Face Velocity, m/s |    |     |     |     |    |    |    |    |
| MS All Lengths | -15                         | 67 | 63  | 61  | 66  | 61 | 64 | 67 | 67 |
|                | -10                         | 60 | 56  | 56  | 56  | 57 | 59 | 58 | 49 |
|                | -5                          | 46 | 45  | 45  | 41  | 50 | 51 | 43 | 23 |
|                | +5                          | 44 | 32  | 36  | 34  | 31 | 32 | 29 | 21 |
|                | +10                         | 63 | 54  | 52  | 50  | 47 | 48 | 47 | 44 |
|                | +15                         | 74 | 64  | 60  | 58  | 56 | 58 | 59 | 57 |

## Aerodynamic Performance

| IAC Model                   | Length (mm) | Static Pressure Drop N/m <sup>2</sup> |      |      |      |     |     |      |      |
|-----------------------------|-------------|---------------------------------------|------|------|------|-----|-----|------|------|
| MS                          | 900         | 15                                    | 20   | 25   | 30   | 35  | 42  | 50   | 57   |
|                             | 1500        | 20                                    | 25   | 30   | 37   | 42  | 50  | 60   | 67   |
|                             | 2100        | 25                                    | 30   | 37   | 45   | 55  | 65  | 75   | 85   |
|                             | 3000        | 30                                    | 37   | 47   | 57   | 67  | 77  | 90   | 105  |
| Silencer Face Velocity, m/s |             | 4.06                                  | 4.57 | 5.08 | 5.59 | 6.1 | 6.6 | 7.11 | 7.62 |

## Face Area Adjustment Factors (add or subtract from Lw values above)

|   |      |      |      |      |      |     |     |     |     |
|---|------|------|------|------|------|-----|-----|-----|-----|
| Quiet-Duct® Face Area, m <sup>2</sup> * | 0.03 | 0.06 | 0.11 | 0.22 | 0.45 | 0.9 | 1.8 | 3.6 | 7.2 |
| Lw Adjustment Factor, dB                | -9   | -6   | -3   | 0    | +3   | +6  | +9  | +12 | +15 |

\* For intermediate face areas, interpolate to the nearest whole number

## Dynamic Insertion Loss (DIL) Ratings: Forward (+) / Reverse (-) Flow

| IAC MS Model (length in mm) | Octave Band                 | 1  | 2   | 3   | 4   | 5  | 6  | 7  | 8  |
|-----------------------------|-----------------------------|----|-----|-----|-----|----|----|----|----|
|                             | Hz                          | 63 | 125 | 250 | 500 | 1K | 2K | 4K | 8K |
|                             | Silencer Face Velocity, m/s |    |     |     |     |    |    |    |    |
| <b>3MS (900)</b>            | -10                         | 5  | 7   | 14  | 24  | 27 | 20 | 12 | 9  |
|                             | -5                          | 6  | 7   | 13  | 24  | 26 | 19 | 13 | 9  |
|                             | 0                           | 5  | 7   | 13  | 23  | 25 | 20 | 15 | 10 |
|                             | 5                           | 4  | 6   | 12  | 21  | 24 | 21 | 16 | 11 |
|                             | 10                          | 3  | 5   | 11  | 18  | 23 | 22 | 17 | 11 |
| <b>4MS (1200)</b>           | -10                         | 6  | 10  | 18  | 31  | 35 | 26 | 16 | 10 |
|                             | -5                          | 6  | 9   | 16  | 30  | 35 | 25 | 16 | 10 |
|                             | 0                           | 5  | 9   | 16  | 29  | 34 | 26 | 18 | 11 |
|                             | 5                           | 4  | 8   | 15  | 28  | 33 | 27 | 19 | 13 |
|                             | 10                          | 3  | 7   | 14  | 25  | 32 | 28 | 20 | 13 |
| <b>5MS (1500)</b>           | -10                         | 7  | 12  | 21  | 38  | 43 | 32 | 19 | 10 |
|                             | -5                          | 5  | 10  | 19  | 36  | 43 | 31 | 19 | 10 |
|                             | 0                           | 5  | 10  | 18  | 35  | 43 | 32 | 21 | 12 |
|                             | 5                           | 4  | 9   | 17  | 34  | 42 | 33 | 22 | 14 |
|                             | 10                          | 3  | 8   | 16  | 32  | 40 | 34 | 22 | 15 |
| <b>6MS (1800)</b>           | -10                         | 8  | 15  | 25  | 40  | 45 | 37 | 22 | 12 |
|                             | -5                          | 6  | 12  | 22  | 39  | 47 | 36 | 22 | 12 |
|                             | 0                           | 6  | 12  | 21  | 39  | 47 | 37 | 24 | 14 |
|                             | 5                           | 6  | 11  | 20  | 38  | 46 | 39 | 25 | 16 |
|                             | 10                          | 5  | 10  | 19  | 36  | 45 | 40 | 26 | 17 |
| <b>7MS (2100)</b>           | -10                         | 8  | 17  | 28  | 41  | 46 | 41 | 24 | 13 |
|                             | -5                          | 7  | 14  | 25  | 42  | 50 | 40 | 24 | 13 |
|                             | 0                           | 7  | 14  | 24  | 42  | 50 | 42 | 26 | 15 |
|                             | 5                           | 7  | 13  | 23  | 41  | 49 | 44 | 28 | 17 |
|                             | 10                          | 6  | 11  | 21  | 40  | 49 | 45 | 30 | 19 |
| <b>8MS (2400)</b>           | -10                         | 9  | 18  | 30  | 42  | 48 | 43 | 26 | 15 |
|                             | -5                          | 8  | 16  | 28  | 43  | 51 | 43 | 27 | 14 |
|                             | 0                           | 8  | 15  | 27  | 43  | 51 | 45 | 29 | 16 |
|                             | 5                           | 8  | 14  | 26  | 42  | 50 | 47 | 31 | 18 |
|                             | 10                          | 7  | 12  | 24  | 41  | 49 | 47 | 33 | 20 |
| <b>9MS (2700)</b>           | -10                         | 11 | 20  | 33  | 42  | 50 | 45 | 29 | 16 |
|                             | -5                          | 10 | 17  | 31  | 44  | 51 | 47 | 30 | 16 |
|                             | 0                           | 10 | 17  | 30  | 44  | 51 | 48 | 33 | 18 |
|                             | 5                           | 9  | 16  | 29  | 44  | 50 | 49 | 35 | 20 |
|                             | 10                          | 8  | 13  | 26  | 43  | 48 | 48 | 37 | 22 |
| <b>10MS (3000)</b>          | -10                         | 12 | 21  | 35  | 43  | 52 | 47 | 31 | 18 |
|                             | -5                          | 11 | 19  | 34  | 45  | 52 | 50 | 33 | 17 |
|                             | 0                           | 11 | 18  | 33  | 45  | 52 | 51 | 36 | 19 |
|                             | 5                           | 10 | 17  | 32  | 45  | 51 | 52 | 38 | 21 |
|                             | 10                          | 9  | 14  | 29  | 44  | 48 | 50 | 40 | 23 |

### Note

- Silencer Face Area is the cross-sectional area at the silencer entrance
- Face Velocity is the airflow (m<sup>3</sup>/s) divided by the Face Area (m<sup>2</sup>)
- Pressure drop for any face velocity can be calculated from the equation:  
 $PD = (\text{Actual FV} / \text{catalogue FV})^2 \times (\text{Catalogue PD})$
- Self Noise values shown are for a 0.22m<sup>2</sup> face area silencer
- For each doubling of face area add 3dB to the self noise values listed
- For each halving of face area subtract 3dB from the self noise values listed

# Quiet-Duct® Silencer Type: LFL

Low Frequency Silencers with Forward and Reverse Flow Ratings

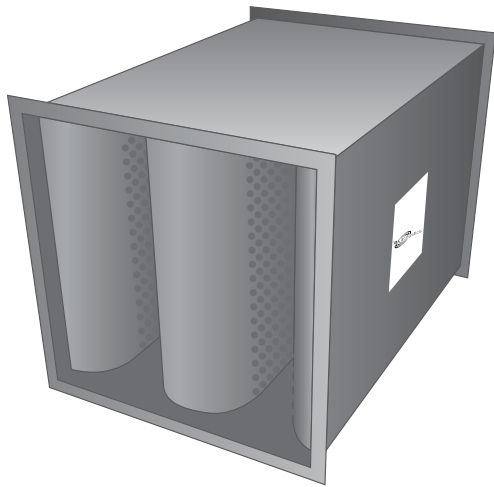

The LFL model is advantageous where low frequency acoustic performance and low pressure drop aerodynamic performance are both essential to the HVAC system. In many applications, higher frequency attenuation is provided by the system components or may not be needed.

### Supplied as Standard

- Aerodynamic inlet and discharge to splitter elements to reduce pressure drop and conserve energy
- Perforated galvanised steel facings to all splitter elements to protect acoustic media from damage and erosion

### Designating Silencers: Example

Model: 5LFL-600-600

| Length | Type | Width | Height |
|--------|------|-------|--------|
| 1500mm | LFL  | 600mm | 600mm  |

### Weight

Average weight 75kg/m<sup>3</sup>

## Self-Noise Power Levels dB re: 10<sup>-12</sup> Watts

| IAC LFL Model   | Octave Band                 | 1  | 2   | 3   | 4   | 5  | 6  | 7  | 8  |
|-----------------|-----------------------------|----|-----|-----|-----|----|----|----|----|
|                 | Hz                          | 63 | 125 | 250 | 500 | 1K | 2K | 4K | 8K |
|                 | Silencer Face Velocity, m/s |    |     |     |     |    |    |    |    |
| LFL All Lengths | -15                         | 55 | 54  | 56  | 57  | 56 | 59 | 61 | 56 |
|                 | -10                         | 46 | 45  | 48  | 49  | 50 | 54 | 49 | 42 |
|                 | -5                          | 31 | 30  | 34  | 35  | 40 | 45 | 28 | 20 |
|                 | +5                          | 32 | 24  | 32  | 25  | 34 | 39 | 24 | 20 |
|                 | +10                         | 47 | 42  | 46  | 44  | 46 | 51 | 46 | 38 |
|                 | +15                         | 56 | 53  | 54  | 55  | 53 | 58 | 59 | 53 |

## Aerodynamic Performance

| IAC Model                   | Length (mm) | Static Pressure Drop N/m <sup>2</sup> |      |      |     |      |      |      |       |
|-----------------------------|-------------|---------------------------------------|------|------|-----|------|------|------|-------|
|                             |             | 2.03                                  | 4.06 | 5.08 | 6.1 | 7.11 | 8.13 | 9.14 | 10.16 |
| LFL                         | 900         | 2                                     | 12   | 20   | 27  | 37   | 47   | 60   | 75    |
|                             | 1500        | 2                                     | 12   | 20   | 30  | 40   | 50   | 65   | 80    |
|                             | 2100        | 2                                     | 12   | 22   | 30  | 42   | 55   | 70   | 85    |
|                             | 3000        | 5                                     | 15   | 25   | 35  | 47   | 60   | 77   | 95    |
| Silencer Face Velocity, m/s |             | 2.03                                  | 4.06 | 5.08 | 6.1 | 7.11 | 8.13 | 9.14 | 10.16 |

## Face Area Adjustment Factors (add or subtract from Lw values above)

|   |      |      |      |      |      |     |     |     |      |
|---|------|------|------|------|------|-----|-----|-----|------|
| Quiet-Duct® Face Area, m <sup>2</sup> * | 0.05 | 0.09 | 0.19 | 0.37 | 0.74 | 1.5 | 3.0 | 6.0 | 12.0 |
| Lw Adjustment Factor, dB                | -9   | -6   | -3   | 0    | +3   | +6  | +9  | +12 | +15  |

\* For intermediate face areas, interpolate to the nearest whole number

## Dynamic Insertion Loss (DIL) Ratings: Forward (+) / Reverse (-) Flow

| IAC LFL Model (length in mm) | Octave Band                 | 1  | 2   | 3   | 4   | 5  | 6  | 7  | 8  |
|------------------------------|-----------------------------|----|-----|-----|-----|----|----|----|----|
|                              | Hz                          | 63 | 125 | 250 | 500 | 1K | 2K | 4K | 8K |
|                              | Silencer Face Velocity, m/s |    |     |     |     |    |    |    |    |
| 3LFL (900)                   | -10                         | 5  | 7   | 14  | 17  | 17 | 11 | 12 | 10 |
|                              | -5                          | 4  | 7   | 13  | 17  | 17 | 11 | 11 | 10 |
|                              | 0                           | 4  | 8   | 14  | 19  | 19 | 13 | 11 | 10 |
|                              | +5                          | 4  | 8   | 14  | 20  | 20 | 15 | 11 | 10 |
|                              | +10                         | 4  | 8   | 13  | 19  | 20 | 12 | 11 | 9  |
| 4LFL (1200)                  | -10                         | 6  | 10  | 17  | 22  | 23 | 13 | 14 | 12 |
|                              | -5                          | 6  | 10  | 16  | 22  | 22 | 13 | 13 | 12 |
|                              | 0                           | 6  | 9   | 16  | 23  | 23 | 14 | 12 | 11 |
|                              | +5                          | 5  | 9   | 16  | 22  | 23 | 15 | 12 | 11 |
|                              | +10                         | 5  | 9   | 15  | 21  | 23 | 13 | 12 | 10 |
| 5LFL (1500)                  | -10                         | 6  | 12  | 19  | 27  | 28 | 15 | 15 | 13 |
|                              | -5                          | 7  | 12  | 19  | 27  | 27 | 15 | 14 | 13 |
|                              | 0                           | 7  | 11  | 18  | 26  | 26 | 15 | 13 | 12 |
|                              | +5                          | 6  | 10  | 17  | 24  | 25 | 14 | 12 | 11 |
|                              | +10                         | 5  | 10  | 16  | 23  | 25 | 14 | 12 | 11 |
| 6LFL (1800)                  | -10                         | 8  | 14  | 22  | 33  | 30 | 16 | 15 | 13 |
|                              | -5                          | 8  | 13  | 22  | 33  | 30 | 16 | 15 | 14 |
|                              | 0                           | 8  | 12  | 21  | 32  | 29 | 16 | 14 | 13 |
|                              | +5                          | 7  | 11  | 20  | 31  | 28 | 16 | 14 | 12 |
|                              | +10                         | 6  | 11  | 18  | 30  | 28 | 16 | 13 | 12 |
| 7LFL (2100)                  | -10                         | 9  | 15  | 25  | 38  | 32 | 17 | 15 | 13 |
|                              | -5                          | 9  | 14  | 24  | 38  | 32 | 17 | 15 | 14 |
|                              | 0                           | 8  | 13  | 23  | 38  | 32 | 17 | 15 | 14 |
|                              | +5                          | 7  | 12  | 22  | 37  | 31 | 17 | 15 | 13 |
|                              | +10                         | 6  | 12  | 20  | 36  | 31 | 18 | 14 | 13 |
| 8LFL (2400)                  | -10                         | 10 | 17  | 27  | 40  | 35 | 18 | 16 | 14 |
|                              | -5                          | 10 | 16  | 29  | 40  | 35 | 18 | 16 | 14 |
|                              | 0                           | 9  | 15  | 26  | 40  | 35 | 18 | 16 | 14 |
|                              | +5                          | 8  | 14  | 24  | 39  | 34 | 18 | 16 | 14 |
|                              | +10                         | 7  | 13  | 22  | 39  | 34 | 19 | 15 | 14 |
| 9LFL (2700)                  | -10                         | 11 | 18  | 30  | 41  | 39 | 19 | 17 | 14 |
|                              | -5                          | 10 | 17  | 29  | 42  | 39 | 20 | 16 | 15 |
|                              | 0                           | 10 | 16  | 28  | 42  | 39 | 20 | 16 | 15 |
|                              | +5                          | 9  | 15  | 27  | 42  | 38 | 20 | 16 | 14 |
|                              | +10                         | 8  | 15  | 25  | 41  | 38 | 20 | 15 | 14 |
| 10LFL (3000)                 | -10                         | 12 | 20  | 32  | 43  | 42 | 20 | 18 | 15 |
|                              | -5                          | 11 | 19  | 32  | 44  | 42 | 21 | 17 | 15 |
|                              | 0                           | 11 | 18  | 31  | 44  | 42 | 21 | 17 | 15 |
|                              | +5                          | 10 | 17  | 29  | 44  | 41 | 21 | 17 | 15 |
|                              | +10                         | 9  | 16  | 27  | 44  | 41 | 21 | 16 | 15 |

### Note

- Silencer Face Area is the cross-sectional area at the silencer entrance
- Face Velocity is the airflow (m<sup>3</sup>/s) divided by the Face Area (m<sup>2</sup>)
- Pressure drop for any face velocity can be calculated from the equation:  
 $PD = (\text{Actual FV} / \text{catalogue FV})^2 \times (\text{Catalogue PD})$
- Self Noise values shown are for a 0.37m<sup>2</sup> face area silencer
- For each doubling of face area add 3dB to the self noise values listed
- For each halving of face area subtract 3dB from the self noise values listed

# Quiet-Duct® Silencer Type: ML

With Forward and Reverse Flow

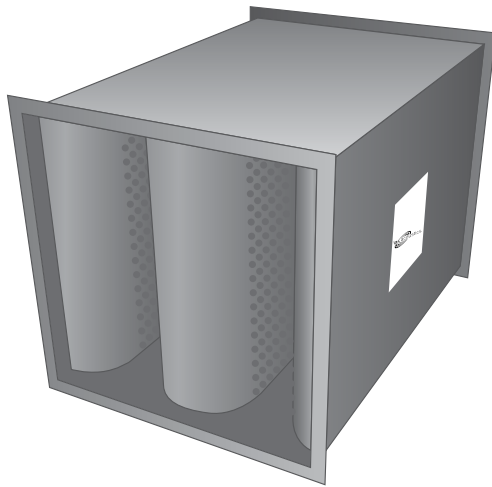

### Supplied as Standard

- Aerodynamic inlet and discharge to splitter elements to reduce pressure drop and conserve energy
- Perforated galvanised steel facings to all splitter elements to protect acoustic media from damage and erosion

### Designating Silencers: Example

Model: 5ML-450-600

| Length | Type | Width | Height |
|--------|------|-------|--------|
| 1500mm | ML   | 450mm | 600mm  |

### Weight

Average weight 85kg/m<sup>3</sup>

## Self-Noise Power Levels dB re: 10<sup>-12</sup> Watts

| IAC ML Model   | Octave Band                 | 1  | 2   | 3   | 4   | 5  | 6  | 7  | 8  |
|----------------|-----------------------------|----|-----|-----|-----|----|----|----|----|
|                | Hz                          | 63 | 125 | 250 | 500 | 1K | 2K | 4K | 8K |
|                | Silencer Face Velocity, m/s |    |     |     |     |    |    |    |    |
| ML All Lengths | -15                         | 64 | 59  | 59  | 63  | 60 | 62 | 63 | 59 |
|                | -10                         | 56 | 53  | 52  | 53  | 56 | 58 | 52 | 44 |
|                | -5                          | 42 | 42  | 41  | 38  | 49 | 50 | 37 | 20 |
|                | +5                          | 39 | 35  | 30  | 27  | 26 | 28 | 28 | 20 |
|                | +10                         | 58 | 52  | 46  | 43  | 42 | 45 | 45 | 39 |
|                | +15                         | 71 | 61  | 55  | 53  | 51 | 55 | 56 | 52 |

## Aerodynamic Performance

| IAC Model                   | Length (mm) | Static Pressure Drop N/m <sup>2</sup> |     |      |      |      |       |       |       |
|-----------------------------|-------------|---------------------------------------|-----|------|------|------|-------|-------|-------|
|                             |             | 1                                     | 2   | 3    | 4    | 5    | 6     | 7     | 8     |
| ML                          | 900         | 12                                    | 17  | 25   | 32   | 40   | 50    | 60    | 70    |
|                             | 1500        | 15                                    | 20  | 30   | 37   | 47   | 60    | 70    | 85    |
|                             | 2100        | 17                                    | 27  | 35   | 47   | 60   | 72    | 90    | 105   |
|                             | 3000        | 22                                    | 32  | 45   | 57   | 72   | 90    | 110   | 130   |
| Silencer Face Velocity, m/s |             | 5.08                                  | 6.1 | 7.11 | 8.13 | 9.14 | 10.16 | 11.18 | 12.19 |

## Face Area Adjustment Factors (add or subtract from Lw values above)

|   |      |      |      |      |      |      |      |      |      |
|---|------|------|------|------|------|------|------|------|------|
| Quiet-Duct® Face Area, m <sup>2</sup> * | 0.03 | 0.07 | 0.13 | 0.27 | 0.54 | 1.08 | 2.16 | 4.32 | 8.64 |
| Lw Adjustment Factor, dB                | -9   | -6   | -3   | 0    | +3   | +6   | +9   | +12  | +15  |

\* For intermediate face areas, interpolate to the nearest whole number

## Dynamic Insertion Loss (DIL) Ratings: Forward (+) / Reverse (-) Flow

| IAC ML Model (length in mm) | Octave Band                 | 1  | 2   | 3   | 4   | 5  | 6  | 7  | 8  |
|-----------------------------|-----------------------------|----|-----|-----|-----|----|----|----|----|
|                             | Hz                          | 63 | 125 | 250 | 500 | 1K | 2K | 4K | 8K |
|                             | Silencer Face Velocity, m/s |    |     |     |     |    |    |    |    |
| <b>3ML (900)</b>            | -10                         | 4  | 5   | 12  | 20  | 18 | 11 | 7  | 5  |
|                             | -5                          | 3  | 5   | 10  | 19  | 18 | 12 | 8  | 6  |
|                             | 0                           | 3  | 5   | 10  | 19  | 18 | 12 | 9  | 7  |
|                             | 5                           | 3  | 4   | 9   | 18  | 17 | 12 | 9  | 8  |
|                             | 10                          | 2  | 4   | 8   | 16  | 17 | 13 | 10 | 9  |
| <b>4ML (1200)</b>           | -10                         | 5  | 7   | 15  | 26  | 25 | 14 | 8  | 6  |
|                             | -5                          | 4  | 7   | 13  | 25  | 25 | 15 | 9  | 7  |
|                             | 0                           | 4  | 7   | 13  | 25  | 25 | 16 | 11 | 8  |
|                             | 5                           | 4  | 6   | 12  | 24  | 24 | 16 | 11 | 9  |
|                             | 10                          | 3  | 5   | 11  | 22  | 23 | 18 | 12 | 10 |
| <b>5ML (1500)</b>           | -10                         | 6  | 9   | 18  | 32  | 32 | 17 | 9  | 6  |
|                             | -5                          | 5  | 8   | 16  | 31  | 31 | 17 | 10 | 7  |
|                             | 0                           | 5  | 8   | 15  | 31  | 31 | 19 | 12 | 9  |
|                             | 5                           | 4  | 7   | 14  | 30  | 30 | 20 | 13 | 10 |
|                             | 10                          | 3  | 6   | 14  | 28  | 29 | 22 | 13 | 11 |
| <b>6ML (1800)</b>           | -10                         | 6  | 11  | 20  | 37  | 38 | 21 | 12 | 8  |
|                             | -5                          | 6  | 10  | 19  | 36  | 36 | 20 | 13 | 9  |
|                             | 0                           | 6  | 10  | 18  | 35  | 36 | 22 | 14 | 10 |
|                             | 5                           | 5  | 9   | 17  | 34  | 35 | 23 | 15 | 11 |
|                             | 10                          | 4  | 8   | 16  | 32  | 34 | 25 | 15 | 12 |
| <b>7ML (2100)</b>           | -10                         | 6  | 12  | 22  | 42  | 43 | 24 | 14 | 10 |
|                             | -5                          | 6  | 11  | 21  | 41  | 40 | 23 | 15 | 10 |
|                             | 0                           | 6  | 11  | 20  | 39  | 40 | 25 | 16 | 11 |
|                             | 5                           | 5  | 10  | 19  | 37  | 39 | 26 | 16 | 12 |
|                             | 10                          | 5  | 9   | 17  | 36  | 38 | 28 | 16 | 12 |
| <b>8ML (2400)</b>           | -10                         | 7  | 14  | 24  | 43  | 44 | 27 | 16 | 10 |
|                             | -5                          | 7  | 13  | 23  | 43  | 43 | 26 | 17 | 11 |
|                             | 0                           | 7  | 13  | 22  | 41  | 43 | 28 | 17 | 11 |
|                             | 5                           | 6  | 12  | 21  | 40  | 42 | 29 | 17 | 12 |
|                             | 10                          | 6  | 11  | 19  | 39  | 42 | 31 | 18 | 13 |
| <b>9ML (2700)</b>           | -10                         | 8  | 16  | 26  | 45  | 46 | 31 | 17 | 11 |
|                             | -5                          | 7  | 15  | 25  | 45  | 47 | 30 | 18 | 11 |
|                             | 0                           | 7  | 14  | 24  | 44  | 47 | 32 | 19 | 12 |
|                             | 5                           | 6  | 13  | 23  | 42  | 46 | 33 | 19 | 12 |
|                             | 10                          | 6  | 13  | 21  | 41  | 46 | 33 | 19 | 13 |
| <b>10ML (3000)</b>          | -10                         | 9  | 18  | 28  | 46  | 47 | 34 | 19 | 11 |
|                             | -5                          | 8  | 17  | 27  | 47  | 50 | 33 | 20 | 12 |
|                             | 0                           | 8  | 16  | 26  | 46  | 50 | 35 | 20 | 12 |
|                             | 5                           | 7  | 15  | 25  | 45  | 49 | 36 | 20 | 12 |
|                             | 10                          | 7  | 15  | 23  | 44  | 50 | 36 | 21 | 14 |

### Note

- Silencer Face Area is the cross-sectional area at the silencer entrance
- Face Velocity is the airflow (m<sup>3</sup>/s) divided by the Face Area (m<sup>2</sup>)
- Pressure drop for any face velocity can be calculated from the equation:  
 $PD = (\text{Actual FV} / \text{catalogue FV})^2 \times (\text{Catalogue PD})$
- Self Noise values shown are for a 0.27m<sup>2</sup> face area silencer
- For each doubling of face area add 3dB to the self noise values listed
- For each halving of face area subtract 3dB from the self noise values listed

# Quiet-Duct® Silencer Type: L

With Forward and Reverse Flow Ratings

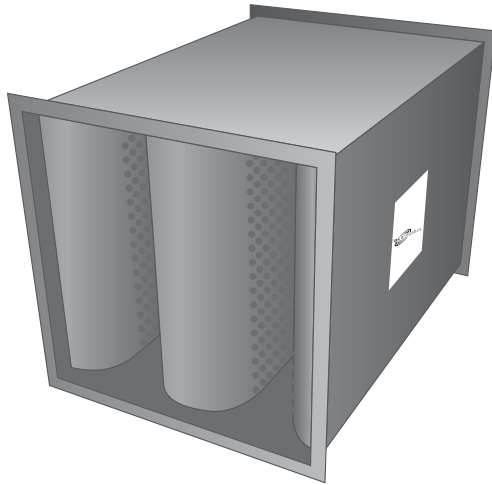

### Supplied as Standard

- Aerodynamic inlet and discharge to splitter elements to reduce pressure drop and conserve energy
- Perforated galvanised steel facings to all splitter elements to protect acoustic media from damage and erosion

### Designating Silencers: Example

Model: 5L-600-600

| Length | Type | Width | Height |
|--------|------|-------|--------|
| 1500mm | L    | 600mm | 600mm  |

### Weight

Average weight 95kg/m<sup>3</sup>

## Self-Noise Power Levels dB re: 10<sup>-12</sup> Watts

| IAC L Model   | Octave Band                 | 1  | 2   | 3   | 4   | 5  | 6  | 7  | 8  |
|---------------|-----------------------------|----|-----|-----|-----|----|----|----|----|
|               | Hz                          | 63 | 125 | 250 | 500 | 1K | 2K | 4K | 8K |
|               | Silencer Face Velocity, m/s |    |     |     |     |    |    |    |    |
| L All Lengths | -15                         | 64 | 59  | 58  | 62  | 60 | 62 | 62 | 58 |
|               | -10                         | 55 | 52  | 52  | 53  | 56 | 56 | 56 | 43 |
|               | -5                          | 41 | 41  | 41  | 38  | 49 | 48 | 38 | 20 |
|               | +5                          | 38 | 31  | 37  | 32  | 32 | 36 | 24 | 20 |
|               | +10                         | 57 | 51  | 51  | 49  | 47 | 50 | 44 | 35 |
|               | +15                         | 68 | 63  | 59  | 60  | 56 | 58 | 56 | 50 |

## Aerodynamic Performance

| IAC Model                   | Length (mm) | Static Pressure Drop N/m <sup>2</sup> |     |      |      |      |       |       |       |
|-----------------------------|-------------|---------------------------------------|-----|------|------|------|-------|-------|-------|
|                             |             | 1                                     | 2   | 3    | 4    | 5    | 6     | 7     | 8     |
| L                           | 900         | 12                                    | 17  | 25   | 32   | 40   | 50    | 60    | 72    |
|                             | 1500        | 15                                    | 20  | 27   | 35   | 45   | 55    | 67    | 80    |
|                             | 2100        | 15                                    | 22  | 30   | 37   | 47   | 60    | 72    | 87    |
|                             | 3000        | 17                                    | 25  | 32   | 42   | 55   | 67    | 82    | 97    |
| Silencer Face Velocity, m/s |             | 5.08                                  | 6.1 | 7.11 | 8.13 | 9.14 | 10.16 | 11.18 | 12.19 |

## Face Area Adjustment Factors (add or subtract from Lw values above)

| Quiet-Duct® Face Area, m <sup>2</sup> * | 0.03 | 0.09 | 0.19 | 0.37 | 0.74 | 1.50 | 3.00 | 6.00 | 12.00 |
|---|------|------|------|------|------|------|------|------|-------|
| Lw Adjustment Factor, dB                | -9   | -6   | -3   | 0    | +3   | +6   | +9   | +12  | +15   |

\* For intermediate face areas, interpolate to the nearest whole number



## Dynamic Insertion Loss (DIL) Ratings: Forward (+) / Reverse (-) Flow

| IAC L Model (length in mm) | Octave Band                 | 1  | 2   | 3   | 4   | 5  | 6  | 7  | 8  |
|----------------------------|-----------------------------|----|-----|-----|-----|----|----|----|----|
|                            | Hz                          | 63 | 125 | 250 | 500 | 1K | 2K | 4K | 8K |
|                            | Silencer Face Velocity, m/s |    |     |     |     |    |    |    |    |
| 3L (900)                   | -10                         | 4  | 7   | 10  | 16  | 23 | 18 | 12 | 7  |
|                            | -5                          | 3  | 5   | 9   | 15  | 22 | 19 | 12 | 8  |
|                            | 0                           | 3  | 5   | 9   | 15  | 22 | 21 | 13 | 9  |
|                            | +5                          | 3  | 5   | 8   | 14  | 21 | 22 | 13 | 9  |
|                            | +10                         | 2  | 4   | 7   | 13  | 19 | 22 | 14 | 10 |
| 4L (1200)                  | -10                         | 5  | 9   | 13  | 21  | 28 | 25 | 14 | 8  |
|                            | -5                          | 4  | 7   | 12  | 20  | 27 | 26 | 14 | 9  |
|                            | 0                           | 4  | 7   | 12  | 19  | 27 | 28 | 15 | 11 |
|                            | +5                          | 4  | 6   | 11  | 18  | 26 | 29 | 16 | 11 |
|                            | +10                         | 3  | 5   | 9   | 17  | 24 | 29 | 17 | 12 |
| 5L (1500)                  | -10                         | 6  | 10  | 15  | 25  | 33 | 32 | 16 | 9  |
|                            | -5                          | 5  | 8   | 14  | 24  | 32 | 32 | 16 | 10 |
|                            | 0                           | 5  | 8   | 14  | 23  | 31 | 34 | 17 | 12 |
|                            | +5                          | 5  | 7   | 13  | 22  | 30 | 35 | 18 | 13 |
|                            | +10                         | 4  | 6   | 11  | 20  | 28 | 35 | 19 | 13 |
| 6L (1800)                  | -10                         | 7  | 13  | 18  | 29  | 38 | 36 | 19 | 11 |
|                            | -5                          | 6  | 10  | 16  | 28  | 37 | 36 | 18 | 12 |
|                            | 0                           | 6  | 10  | 16  | 27  | 36 | 38 | 19 | 13 |
|                            | +5                          | 6  | 9   | 15  | 26  | 35 | 39 | 20 | 14 |
|                            | +10                         | 5  | 7   | 13  | 24  | 33 | 39 | 22 | 15 |
| 7L (2100)                  | -10                         | 7  | 15  | 20  | 33  | 42 | 39 | 21 | 12 |
|                            | -5                          | 6  | 12  | 18  | 31  | 42 | 40 | 20 | 13 |
|                            | 0                           | 6  | 12  | 17  | 30  | 41 | 42 | 21 | 14 |
|                            | +5                          | 6  | 11  | 16  | 29  | 39 | 43 | 22 | 15 |
|                            | +10                         | 5  | 8   | 15  | 28  | 37 | 43 | 24 | 16 |
| 8L (2400)                  | -10                         | 8  | 17  | 23  | 40  | 44 | 41 | 23 | 13 |
|                            | -5                          | 7  | 13  | 20  | 35  | 44 | 43 | 25 | 14 |
|                            | 0                           | 7  | 13  | 19  | 34  | 43 | 44 | 24 | 16 |
|                            | +5                          | 7  | 12  | 18  | 33  | 42 | 45 | 24 | 17 |
|                            | +10                         | 6  | 9   | 17  | 32  | 40 | 45 | 27 | 18 |
| 9L (2700)                  | -10                         | 8  | 18  | 25  | 40  | 45 | 44 | 26 | 15 |
|                            | -5                          | 8  | 15  | 23  | 38  | 46 | 45 | 25 | 16 |
|                            | 0                           | 8  | 14  | 22  | 37  | 46 | 47 | 26 | 17 |
|                            | +5                          | 8  | 13  | 21  | 36  | 45 | 47 | 27 | 18 |
|                            | +10                         | 7  | 11  | 19  | 35  | 44 | 47 | 29 | 20 |
| 10L (3000)                 | -10                         | 9  | 20  | 28  | 44  | 47 | 46 | 28 | 16 |
|                            | -5                          | 9  | 16  | 25  | 42  | 48 | 48 | 28 | 17 |
|                            | 0                           | 9  | 15  | 24  | 41  | 48 | 49 | 29 | 19 |
|                            | +5                          | 9  | 14  | 23  | 40  | 48 | 49 | 29 | 20 |
|                            | +10                         | 8  | 12  | 21  | 39  | 47 | 49 | 32 | 22 |

### Note

- Silencer Face Area is the cross-sectional area at the silencer entrance
- Face Velocity is the airflow (m<sup>3</sup>/s) divided by the Face Area (m<sup>2</sup>)
- Pressure drop for any face velocity can be calculated from the equation:  
 $PD = (\text{Actual FV} / \text{catalogue FV})^2 \times (\text{Catalogue PD})$
- Self Noise values shown are for a 0.37m<sup>2</sup> face area silencer
- For each doubling of face area add 3dB to the self noise values listed
- For each halving of face area subtract 3dB from the self noise values listed

# Conic-Flow® Silencer Type: CS

With Forward and Reverse Flow Ratings

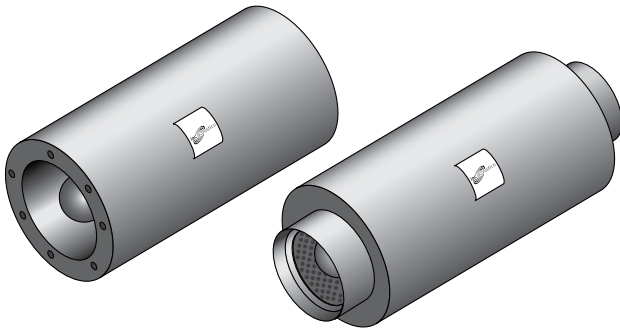

## Supplied as Standard

- Aerodynamic inlet and discharge to splitter elements to reduce pressure drop and conserve energy
- Perforated galvanised steel facings to all splitter elements to protect acoustic media from damage and erosion

## Designating Silencers: Example

Model: 300-CS-900

| Pipe Diameter | Type | Length |
|---------------|------|--------|
| 300mm         | CS   | 900mm  |

## Dynamic Insertion Loss (DIL) Ratings: Forward (+) / Reverse (-) Flow

| IAC CS Model (pipe diameter in mm) | Octave Band                 | 1  | 2   | 3   | 4   | 5  | 6  | 7  | 8  |
|------------------------------------|-----------------------------|----|-----|-----|-----|----|----|----|----|
|                                    | Hz                          | 63 | 125 | 250 | 500 | 1K | 2K | 4K | 8K |
|                                    | Silencer Face Velocity, m/s |    |     |     |     |    |    |    |    |
| 300-CS-900                         | -20                         | 9  | 13  | 22  | 32  | 36 | 35 | 31 | 21 |
|                                    | -10                         | 7  | 10  | 19  | 31  | 34 | 35 | 32 | 26 |
|                                    | 0                           | 6  | 10  | 18  | 31  | 34 | 36 | 33 | 27 |
|                                    | +10                         | 4  | 9   | 16  | 30  | 34 | 37 | 33 | 27 |
|                                    | +20                         | 3  | 8   | 14  | 29  | 33 | 39 | 33 | 27 |
| 300-CS-1200                        | -20                         | 10 | 12  | 20  | 34  | 43 | 34 | 20 | 11 |
|                                    | -10                         | 8  | 11  | 18  | 34  | 40 | 35 | 22 | 13 |
|                                    | 0                           | 7  | 11  | 18  | 30  | 38 | 36 | 23 | 17 |
|                                    | +10                         | 5  | 11  | 18  | 26  | 36 | 37 | 24 | 20 |
|                                    | +20                         | 4  | 10  | 17  | 25  | 34 | 37 | 27 | 21 |
| 300-CS-1800                        | -20                         | 11 | 16  | 22  | 36  | 38 | 28 | 19 | 11 |
|                                    | -10                         | 10 | 15  | 20  | 35  | 37 | 29 | 21 | 12 |
|                                    | 0                           | 10 | 15  | 20  | 35  | 37 | 30 | 22 | 15 |
|                                    | +10                         | 9  | 14  | 19  | 35  | 36 | 31 | 23 | 17 |
|                                    | +20                         | 8  | 13  | 18  | 33  | 35 | 32 | 24 | 18 |
| 300-CS-2400                        | -20                         | 12 | 18  | 23  | 37  | 36 | 20 | 13 | 11 |
|                                    | -10                         | 11 | 17  | 21  | 36  | 35 | 22 | 14 | 12 |
|                                    | 0                           | 11 | 17  | 21  | 35  | 35 | 24 | 17 | 14 |
|                                    | +10                         | 10 | 16  | 20  | 34  | 35 | 26 | 20 | 16 |
|                                    | +20                         | 9  | 14  | 19  | 34  | 35 | 27 | 21 | 17 |
| 300-CS-3000                        | -20                         | 13 | 20  | 25  | 38  | 33 | 16 | 11 | 10 |
|                                    | -10                         | 12 | 19  | 24  | 36  | 32 | 18 | 12 | 11 |
|                                    | 0                           | 12 | 18  | 24  | 36  | 32 | 21 | 15 | 13 |
|                                    | +10                         | 11 | 17  | 23  | 35  | 31 | 23 | 17 | 15 |
|                                    | +20                         | 10 | 15  | 22  | 35  | 31 | 24 | 18 | 16 |

## Self-Noise Power Levels dB re: 10<sup>-12</sup> Watts

| IAC CS Model               | Octave Band                 | 1  | 2   | 3   | 4   | 5  | 6  | 7  | 8  |
|----------------------------|-----------------------------|----|-----|-----|-----|----|----|----|----|
|                            | Hz                          | 63 | 125 | 250 | 500 | 1K | 2K | 4K | 8K |
|                            | Silencer Face Velocity, m/s |    |     |     |     |    |    |    |    |
| CS All Pipe Diameters (mm) | -15                         | 57 | 58  | 58  | 57  | 56 | 57 | 56 | 52 |
|                            | -10                         | 50 | 49  | 51  | 49  | 46 | 47 | 45 | 39 |
|                            | -5                          | 38 | 34  | 39  | 35  | 29 | 30 | 26 | 20 |
|                            | +5                          | 44 | 43  | 37  | 37  | 38 | 38 | 20 | 20 |
|                            | +10                         | 56 | 54  | 50  | 50  | 50 | 50 | 41 | 31 |
|                            | +15                         | 63 | 60  | 57  | 57  | 57 | 57 | 53 | 47 |

## Physical and Aerodynamic Performance

| Physical Data      |                                      |                    |             |             | Type                         | Static Pressure Drop |       |       |       |       |       |       |       |       |       |
|--------------------|--------------------------------------|--------------------|-------------|-------------|------------------------------|----------------------|-------|-------|-------|-------|-------|-------|-------|-------|-------|
| Pipe Diameter (mm) | Silencer Face Area (m <sup>2</sup> ) | Body Diameter (mm) | Length (mm) | Weight (kg) | CS                           | 98                   | 146   | 196   | 244   | 295   | 393   | 491   | -     | -     | -     |
|                    |                                      |                    |             |             | Airflow in m <sup>3</sup> /s |                      |       |       |       |       |       |       |       |       |       |
| 300                | 0.070                                | 500                | 900         | 34          |                              | 0.84                 | 1.03  | 1.19  | 1.34  | 1.46  | 1.68  | 1.90  | 2.07  | 2.31  | 2.68  |
| 350                | 0.095                                | 550                | 900         | 39          |                              | 1.16                 | 1.42  | 1.64  | 1.85  | 2.02  | 2.32  | 2.61  | 2.85  | 3.2   | 3.69  |
| 400                | 0.125                                | 600                | 900         | 48          |                              | 1.55                 | 1.90  | 2.19  | 2.46  | 2.70  | 3.10  | 3.48  | 3.80  | 4.26  | 4.92  |
| 450                | 0.160                                | 650                | 900         | 55          |                              | 2.03                 | 2.49  | 2.88  | 3.21  | 3.53  | 4.07  | 4.55  | 4.98  | 6.09  | 6.82  |
| 500                | 0.195                                | 700                | 1000        | 61          |                              | 2.52                 | 2.94  | 3.56  | 3.97  | 4.35  | 5.04  | 5.63  | 6.16  | 6.89  | 7.95  |
| 600                | 0.240                                | 750                | 1100        | 68          |                              | 3.11                 | 3.81  | 4.39  | 4.93  | 5.37  | 6.21  | 6.96  | 7.62  | 8.53  | 9.86  |
| 600                | 0.285                                | 800                | 1200        | 75          |                              | 3.75                 | 4.60  | 5.31  | 5.95  | 6.51  | 7.50  | 8.40  | 9.20  | 10.26 | 11.89 |
| 650                | 0.330                                | 850                | 1300        | 84          |                              | 4.43                 | 5.41  | 6.26  | 7.00  | 7.64  | 8.84  | 9.91  | 10.86 | 12.19 | 14.02 |
| 700                | 0.385                                | 900                | 1400        | 91          |                              | 5.16                 | 6.30  | 7.27  | 8.20  | 8.91  | 10.31 | 11.60 | 12.60 | 14.26 | 16.40 |
| 750                | 0.440                                | 950                | 1500        | 139         |                              | 5.91                 | 7.24  | 8.36  | 9.32  | 10.25 | 11.82 | 12.98 | 14.49 | 16.21 | 18.64 |
| 800                | 0.500                                | 1000               | 1600        | 191         |                              | 6.78                 | 8.29  | 9.58  | 10.78 | 11.76 | 13.55 | 15.24 | 16.57 | 18.68 | 21.56 |
| 900                | 0.635                                | 1100               | 1800        | 241         |                              | 8.62                 | 10.57 | 12.17 | 13.72 | 14.95 | 17.23 | 19.40 | 21.13 | 23.78 | 27.44 |
| 1000               | 0.785                                | 1200               | 2000        | 291         |                              | 10.74                | 13.12 | 15.17 | 17.06 | 18.57 | 21.48 | 24.13 | 26.25 | 29.65 | 34.12 |
| 1100               | 0.950                                | 1300               | 2200        | 373         |                              | 13.13                | 16.07 | 18.55 | 20.86 | 22.72 | 26.26 | 29.50 | 32.15 | 36.07 | 41.72 |
| 1200               | 1.130                                | 1400               | 2400        | 450         |                              | 15.73                | 19.27 | 22.25 | 24.90 | 27.25 | 31.47 | 35.18 | 38.55 | 43.11 | 49.79 |
| 1300               | 1.325                                | 1500               | 2600        | 532         |                              | 18.73                | 22.88 | 26.46 | 29.56 | 32.36 | 37.47 | 41.77 | 45.77 | 51.25 | 59.13 |
| 1400               | 1.540                                | 1600               | 2800        | 611         |                              | 21.86                | 26.66 | 30.91 | 34.68 | 37.70 | 43.73 | 48.75 | 53.32 | 60.07 | 69.37 |
| 1500               | 1.765                                | 1700               | 3000        | 755         |                              | 25.04                | 30.75 | 35.60 | 40.02 | 43.48 | 50.09 | 56.58 | 61.50 | 69.37 | 80.03 |

## Note

- The tabulated flow in m<sup>3</sup>/s is based upon tests in the IAC Acoustics R&D Laboratory, in accordance with applicable sections of internationally recognised airflow test codes. These codes require specific lengths of stright duct both upstream and downstream of the test specimen. Non-compliance with these codes can add from 0.5 to several velocity heads depending on specific conditions. The downstream measurements are made far enough downstream to include static regain. Therefore, if silencers are installed immediately before or after elbows, transitions or at the intake or discharge of the system, sufficient allowance to compensate for these factors must be included when calculating the operating static pressure loss through the silencer. See pages 10 and 11 for further details.
- Face Velocity is the airflow (m<sup>3</sup>/s) divided by the Face Area (m<sup>2</sup>)
- Pressure drop for any face velocity can be calculated from the equation:  
 $PD = (\text{Actual FV} / \text{catalogue FV})^2 \times (\text{Catalogue PD})$
- Self Noise values shown are for a 0.37m<sup>2</sup> face area silencer
  - For each doubling of face area add 3dB to the self noise values listed
  - For each halving of face area subtract 3dB from the self noise values listed

# Conic-Flow® Silencer Type: CL

With Forward and Reverse Flow Ratings

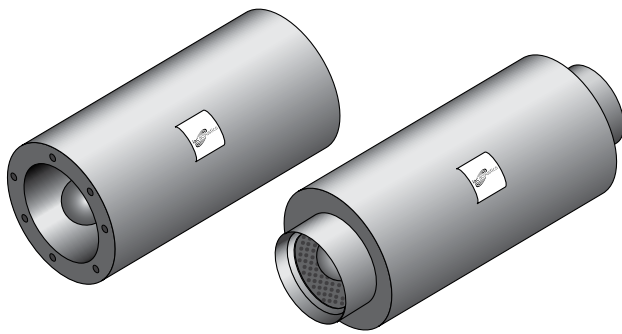

## Supplied as Standard

- Aerodynamic inlet and discharge to splitter elements to reduce pressure drop and conserve energy
- Perforated galvanised steel facings to all splitter elements to protect acoustic media from damage and erosion

## Designating Silencers: Example

Model: 300-CL-900

| Pipe Diameter | Type | Length |
|---------------|------|--------|
| 300mm         | CL   | 900mm  |

## Dynamic Insertion Loss (DIL) Ratings: Forward (+) / Reverse (-) Flow

| IAC CL Model (pipe diameter in mm) | Octave Band                 | 1  | 2   | 3   | 4   | 5  | 6  | 7  | 8  |
|------------------------------------|-----------------------------|----|-----|-----|-----|----|----|----|----|
|                                    | Hz                          | 63 | 125 | 250 | 500 | 1K | 2K | 4K | 8K |
|                                    | Silencer Face Velocity, m/s |    |     |     |     |    |    |    |    |
| 300-CL-900                         | -20                         | 7  | 9   | 17  | 32  | 35 | 34 | 22 | 12 |
|                                    | -10                         | 4  | 8   | 16  | 31  | 34 | 34 | 24 | 13 |
|                                    | 0                           | 4  | 7   | 15  | 30  | 34 | 35 | 24 | 15 |
|                                    | +10                         | 4  | 6   | 13  | 29  | 34 | 36 | 24 | 16 |
|                                    | +20                         | 4  | 6   | 13  | 26  | 33 | 36 | 24 | 17 |
| 600-CL-1200                        | -20                         | 7  | 9   | 16  | 28  | 35 | 21 | 17 | 12 |
|                                    | -10                         | 6  | 9   | 14  | 27  | 35 | 23 | 18 | 13 |
|                                    | 0                           | 6  | 9   | 14  | 27  | 35 | 24 | 20 | 16 |
|                                    | +10                         | 5  | 8   | 13  | 26  | 34 | 25 | 22 | 18 |
|                                    | +20                         | 4  | 8   | 13  | 25  | 34 | 26 | 22 | 18 |
| 900-CL-1800                        | -20                         | 9  | 12  | 18  | 32  | 30 | 19 | 16 | 11 |
|                                    | -10                         | 8  | 12  | 17  | 32  | 29 | 20 | 17 | 12 |
|                                    | 0                           | 8  | 12  | 17  | 32  | 29 | 23 | 19 | 15 |
|                                    | +10                         | 7  | 11  | 16  | 31  | 29 | 25 | 20 | 17 |
|                                    | +20                         | 7  | 10  | 15  | 31  | 28 | 25 | 20 | 17 |
| 1200-CL-2400                       | -20                         | 10 | 15  | 21  | 34  | 30 | 17 | 13 | 10 |
|                                    | -10                         | 10 | 14  | 20  | 33  | 30 | 18 | 14 | 11 |
|                                    | 0                           | 10 | 14  | 19  | 33  | 30 | 20 | 16 | 14 |
|                                    | +10                         | 9  | 14  | 18  | 33  | 29 | 22 | 18 | 16 |
|                                    | +20                         | 8  | 12  | 17  | 33  | 28 | 22 | 18 | 17 |
| 1500-CL-3000                       | -20                         | 12 | 17  | 22  | 35  | 29 | 15 | 11 | 10 |
|                                    | -10                         | 11 | 17  | 21  | 35  | 29 | 16 | 12 | 11 |
|                                    | 0                           | 11 | 17  | 21  | 35  | 28 | 18 | 14 | 13 |
|                                    | +10                         | 11 | 16  | 20  | 35  | 27 | 20 | 16 | 15 |
|                                    | +20                         | 10 | 14  | 19  | 35  | 26 | 20 | 16 | 16 |

## Self-Noise Power Levels dB re: 10<sup>-12</sup> Watts

| IAC CL Model               | Octave Band                 | 1  | 2   | 3   | 4   | 5  | 6  | 7  | 8  |
|----------------------------|-----------------------------|----|-----|-----|-----|----|----|----|----|
|                            | Hz                          | 63 | 125 | 250 | 500 | 1K | 2K | 4K | 8K |
|                            | Silencer Face Velocity, m/s |    |     |     |     |    |    |    |    |
| CL All Pipe Diameters (mm) | -15                         | 56 | 56  | 55  | 56  | 55 | 55 | 50 | 45 |
|                            | -10                         | 47 | 47  | 47  | 47  | 45 | 45 | 37 | 29 |
|                            | -5                          | 31 | 32  | 32  | 31  | 30 | 30 | 20 | 20 |
|                            | +5                          | 39 | 35  | 32  | 32  | 30 | 25 | 20 | 20 |
|                            | +10                         | 52 | 48  | 46  | 46  | 45 | 42 | 39 | 25 |
|                            | +15                         | 60 | 56  | 54  | 54  | 53 | 52 | 50 | 40 |

## Physical and Aerodynamic Performance

| Physical Data      |                                      |                    |             |             | Type | Static Pressure Drop         |       |       |       |       |       |       |       |       |       |  |
|--------------------|--------------------------------------|--------------------|-------------|-------------|------|------------------------------|-------|-------|-------|-------|-------|-------|-------|-------|-------|--|
| Pipe Diameter (mm) | Silencer Face Area (m <sup>2</sup> ) | Body Diameter (mm) | Length (mm) | Weight (kg) | CL   | 27                           | 39    | 53    | 66    | 80    | 107   | 133   | 159   | 199   | 265   |  |
|                    |                                      |                    |             |             |      | Airflow in m <sup>3</sup> /s |       |       |       |       |       |       |       |       |       |  |
| 300                | 0.070                                | 500                | 900         | 34          |      | 0.84                         | 1.03  | 1.19  | 1.34  | 1.46  | 1.68  | 1.90  | 2.07  | 2.31  | 2.68  |  |
| 350                | 0.095                                | 550                | 900         | 39          |      | 1.16                         | 1.42  | 1.64  | 1.85  | 2.02  | 2.32  | 2.61  | 2.85  | 3.2   | 3.69  |  |
| 400                | 0.125                                | 600                | 900         | 48          |      | 1.55                         | 1.90  | 2.19  | 2.46  | 2.70  | 3.10  | 3.48  | 3.80  | 4.26  | 4.92  |  |
| 450                | 0.160                                | 650                | 900         | 55          |      | 2.03                         | 2.49  | 2.88  | 3.21  | 3.53  | 4.07  | 4.55  | 4.98  | 6.09  | 6.82  |  |
| 500                | 0.195                                | 700                | 1000        | 61          |      | 2.52                         | 2.94  | 3.56  | 3.97  | 4.35  | 5.04  | 5.63  | 6.16  | 6.89  | 7.95  |  |
| 600                | 0.240                                | 750                | 1100        | 68          |      | 3.11                         | 3.81  | 4.39  | 4.93  | 5.37  | 6.21  | 6.96  | 7.62  | 8.53  | 9.86  |  |
| 600                | 0.285                                | 800                | 1200        | 75          |      | 3.75                         | 4.60  | 5.31  | 5.95  | 6.51  | 7.50  | 8.40  | 9.20  | 10.26 | 11.89 |  |
| 650                | 0.330                                | 850                | 1300        | 84          |      | 4.43                         | 5.41  | 6.26  | 7.00  | 7.64  | 8.84  | 9.91  | 10.86 | 12.19 | 14.02 |  |
| 700                | 0.385                                | 900                | 1400        | 91          |      | 5.16                         | 6.30  | 7.27  | 8.20  | 8.91  | 10.31 | 11.60 | 12.60 | 14.26 | 16.40 |  |
| 750                | 0.440                                | 950                | 1500        | 139         |      | 5.91                         | 7.24  | 8.36  | 9.32  | 10.25 | 11.82 | 12.98 | 14.49 | 16.21 | 18.64 |  |
| 800                | 0.500                                | 1000               | 1600        | 191         |      | 6.78                         | 8.29  | 9.58  | 10.78 | 11.76 | 13.55 | 15.24 | 16.57 | 18.68 | 21.56 |  |
| 900                | 0.635                                | 1100               | 1800        | 241         |      | 8.62                         | 10.57 | 12.17 | 13.72 | 14.95 | 17.23 | 19.40 | 21.13 | 23.78 | 27.44 |  |
| 1000               | 0.785                                | 1200               | 2000        | 291         |      | 10.74                        | 13.12 | 15.17 | 17.06 | 18.57 | 21.48 | 24.13 | 26.25 | 29.65 | 34.12 |  |
| 1100               | 0.950                                | 1300               | 2200        | 373         |      | 13.13                        | 16.07 | 18.55 | 20.86 | 22.72 | 26.26 | 29.50 | 32.15 | 36.07 | 41.72 |  |
| 1200               | 1.130                                | 1400               | 2400        | 450         |      | 15.73                        | 19.27 | 22.25 | 24.90 | 27.25 | 31.47 | 35.18 | 38.55 | 43.11 | 49.79 |  |
| 1300               | 1.325                                | 1500               | 2600        | 532         |      | 18.73                        | 22.88 | 26.46 | 29.56 | 32.36 | 37.47 | 41.77 | 45.77 | 51.25 | 59.13 |  |
| 1400               | 1.540                                | 1600               | 2800        | 611         |      | 21.86                        | 26.66 | 30.91 | 34.68 | 37.70 | 43.73 | 48.75 | 53.32 | 60.07 | 69.37 |  |
| 1500               | 1.765                                | 1700               | 3000        | 755         |      | 25.04                        | 30.75 | 35.60 | 40.02 | 43.48 | 50.09 | 56.58 | 61.50 | 69.37 | 80.03 |  |

### Note

- The tabulated flow in m<sup>3</sup>/s is based upon tests in the IAC Acoustics R&D Laboratory, in accordance with applicable sections of internationally recognised airflow test codes. These codes require specific lengths of straight duct both upstream and downstream of the test specimen. Non-compliance with these codes can add from 0.5 to several velocity heads depending on specific conditions. The downstream measurements are made far enough downstream to include static regain. Therefore, if silencers are installed immediately before or after elbows, transitions or at the intake or discharge of the system, sufficient allowance to compensate for these factors must be included when calculating the operating static pressure loss through the silencer. See pages 10 and 11 for further details.
- Face Velocity is the airflow (m<sup>3</sup>/s) divided by the Face Area (m<sup>2</sup>)
- Pressure drop for any face velocity can be calculated from the equation:  
 $PD = (\text{Actual FV} / \text{catalogue FV})^2 \times (\text{Catalogue PD})$
- Self Noise values shown are for a 0.37m<sup>2</sup> face area silencer
  - For each doubling of face area add 3dB to the self noise values listed
  - For each halving of face area subtract 3dB from the self noise values listed

# Low Frequency Conic-Flow® Silencer Type: FCS

Low Frequency With Forward and Reverse Flow Ratings

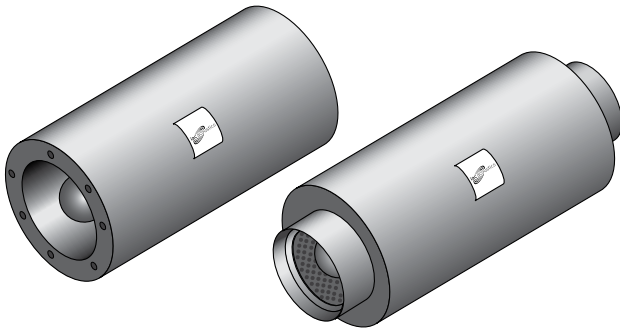

## Supplied as Standard

- Aerodynamic inlet and discharge to splitter elements to reduce pressure drop and conserve energy
- Perforated galvanised steel facings to all splitter elements to protect acoustic media from damage and erosion

## Designating Silencers: Example

Model: 300-FCS-900

| Pipe Diameter | Type | Length |
|---------------|------|--------|
| 300mm         | FCS  | 900mm  |

## Dynamic Insertion Loss (DIL) Ratings: Forward (+) / Reverse (-) Flow

| IAC FCS Model (pipe diameter in mm) | Octave Band                 | 1  | 2   | 3   | 4   | 5  | 6  | 7  | 8  |
|-------------------------------------|-----------------------------|----|-----|-----|-----|----|----|----|----|
|                                     | Hz                          | 63 | 125 | 250 | 500 | 1K | 2K | 4K | 8K |
|                                     | Silencer Face Velocity, m/s |    |     |     |     |    |    |    |    |
| 300-FCS-900                         | -20                         | 10 | 18  | 29  | 42  | 40 | 35 | 31 | 21 |
|                                     | -10                         | 10 | 17  | 27  | 39  | 38 | 35 | 32 | 26 |
|                                     | 0                           | 10 | 16  | 26  | 36  | 36 | 36 | 33 | 26 |
|                                     | +10                         | 9  | 14  | 24  | 33  | 34 | 37 | 34 | 27 |
|                                     | +20                         | 8  | 12  | 22  | 29  | 33 | 39 | 35 | 27 |
| 600-FCS-1200                        | -20                         | 10 | 18  | 31  | 41  | 42 | 35 | 21 | 15 |
|                                     | -10                         | 10 | 16  | 29  | 38  | 40 | 35 | 22 | 17 |
|                                     | 0                           | 9  | 15  | 27  | 36  | 38 | 36 | 22 | 18 |
|                                     | +10                         | 8  | 13  | 25  | 32  | 37 | 35 | 23 | 19 |
|                                     | +20                         | 7  | 12  | 23  | 29  | 35 | 35 | 23 | 20 |
| 900-FCS-1800                        | -20                         | 12 | 21  | 35  | 41  | 40 | 27 | 19 | 14 |
|                                     | -10                         | 11 | 20  | 33  | 38  | 39 | 27 | 21 | 14 |
|                                     | 0                           | 10 | 18  | 31  | 37  | 38 | 27 | 22 | 15 |
|                                     | +10                         | 9  | 16  | 29  | 35  | 36 | 28 | 23 | 16 |
|                                     | +20                         | 8  | 14  | 27  | 33  | 34 | 28 | 24 | 17 |
| 1200-FCS-2400                       | -20                         | 15 | 25  | 39  | 41  | 37 | 23 | 15 | 11 |
|                                     | -10                         | 13 | 22  | 37  | 39  | 36 | 23 | 17 | 12 |
|                                     | 0                           | 12 | 20  | 35  | 37  | 36 | 24 | 19 | 16 |
|                                     | +10                         | 10 | 18  | 33  | 35  | 35 | 24 | 20 | 16 |
|                                     | +20                         | 9  | 16  | 30  | 34  | 35 | 25 | 21 | 17 |
| 1500-FCS-3000                       | -20                         | 18 | 30  | 43  | 41  | 35 | 16 | 12 | 10 |
|                                     | -10                         | 16 | 27  | 41  | 40  | 34 | 17 | 13 | 11 |
|                                     | 0                           | 14 | 25  | 39  | 39  | 33 | 19 | 15 | 13 |
|                                     | +10                         | 12 | 22  | 37  | 37  | 33 | 20 | 16 | 15 |
|                                     | +20                         | 10 | 20  | 34  | 35  | 33 | 22 | 18 | 16 |

## Self-Noise Power Levels dB re: 10<sup>-12</sup> Watts

| IAC FCS Model               | Octave Band                 | 1  | 2   | 3   | 4   | 5  | 6  | 7  | 8  |
|-----------------------------|-----------------------------|----|-----|-----|-----|----|----|----|----|
|                             | Hz                          | 63 | 125 | 250 | 500 | 1K | 2K | 4K | 8K |
|                             | Silencer Face Velocity, m/s |    |     |     |     |    |    |    |    |
| FCS All Pipe Diameters (mm) | -15                         | 57 | 58  | 58  | 57  | 56 | 57 | 56 | 52 |
|                             | -10                         | 50 | 49  | 51  | 49  | 46 | 47 | 45 | 39 |
|                             | -5                          | 38 | 34  | 39  | 35  | 29 | 30 | 26 | 20 |
|                             | +5                          | 44 | 43  | 37  | 37  | 38 | 38 | 20 | 20 |
|                             | +10                         | 56 | 54  | 50  | 50  | 50 | 50 | 41 | 31 |
|                             | +15                         | 63 | 60  | 57  | 57  | 57 | 57 | 53 | 47 |

## Physical and Aerodynamic Performance

| Physical Data      |                                      |                    |             |             | Type                         | Static Pressure Drop |       |       |       |       |       |       |       |       |       |
|--------------------|--------------------------------------|--------------------|-------------|-------------|------------------------------|----------------------|-------|-------|-------|-------|-------|-------|-------|-------|-------|
| Pipe Diameter (mm) | Silencer Face Area (m <sup>2</sup> ) | Body Diameter (mm) | Length (mm) | Weight (kg) | FCS                          | 98                   | 146   | 196   | 244   | 295   | 393   | 491   | -     | -     | -     |
|                    |                                      |                    |             |             | Airflow in m <sup>3</sup> /s |                      |       |       |       |       |       |       |       |       |       |
| 300                | 0.070                                | 700                | 900         | 45          |                              | 0.84                 | 1.03  | 1.19  | 1.34  | 1.46  | 1.68  | 1.90  | 2.07  | 2.31  | 2.68  |
| 350                | 0.095                                | 750                | 900         | 50          |                              | 1.16                 | 1.42  | 1.64  | 1.85  | 2.02  | 2.32  | 2.61  | 2.85  | 3.2   | 3.69  |
| 400                | 0.125                                | 800                | 900         | 60          |                              | 1.55                 | 1.90  | 2.19  | 2.46  | 2.70  | 3.10  | 3.48  | 3.80  | 4.26  | 4.92  |
| 450                | 0.160                                | 850                | 900         | 68          |                              | 2.03                 | 2.49  | 2.88  | 3.21  | 3.53  | 4.07  | 4.55  | 4.98  | 6.09  | 6.82  |
| 500                | 0.195                                | 900                | 1000        | 76          |                              | 2.52                 | 2.94  | 3.56  | 3.97  | 4.35  | 5.04  | 5.63  | 6.16  | 6.89  | 7.95  |
| 600                | 0.240                                | 950                | 1100        | 85          |                              | 3.11                 | 3.81  | 4.39  | 4.93  | 5.37  | 6.21  | 6.96  | 7.62  | 8.53  | 9.86  |
| 600                | 0.285                                | 1000               | 1200        | 95          |                              | 3.75                 | 4.60  | 5.31  | 5.95  | 6.51  | 7.50  | 8.40  | 9.20  | 10.26 | 11.89 |
| 650                | 0.330                                | 1050               | 1300        | 106         |                              | 4.43                 | 5.41  | 6.26  | 7.00  | 7.64  | 8.84  | 9.91  | 10.86 | 12.19 | 14.02 |
| 700                | 0.385                                | 1100               | 1400        | 116         |                              | 5.16                 | 6.30  | 7.27  | 8.20  | 8.91  | 10.31 | 11.60 | 12.60 | 14.26 | 16.40 |
| 750                | 0.440                                | 1150               | 1500        | 170         |                              | 5.91                 | 7.24  | 8.36  | 9.32  | 10.25 | 11.82 | 12.98 | 14.49 | 16.21 | 18.64 |
| 800                | 0.500                                | 1200               | 1600        | 225         |                              | 6.78                 | 8.29  | 9.58  | 10.78 | 11.76 | 13.55 | 15.24 | 16.57 | 18.68 | 21.56 |
| 900                | 0.635                                | 1300               | 1800        | 273         |                              | 8.62                 | 10.57 | 12.17 | 13.72 | 14.95 | 17.23 | 19.40 | 21.13 | 23.78 | 27.44 |
| 1000               | 0.785                                | 1400               | 2000        | 340         |                              | 10.74                | 13.12 | 15.17 | 17.06 | 18.57 | 21.48 | 24.13 | 26.25 | 29.65 | 34.12 |
| 1100               | 0.950                                | 1500               | 2200        | 432         |                              | 13.13                | 16.07 | 18.55 | 20.86 | 22.72 | 26.26 | 29.50 | 32.15 | 36.07 | 41.72 |
| 1200               | 1.130                                | 1600               | 2400        | 518         |                              | 15.73                | 19.27 | 22.25 | 24.90 | 27.25 | 31.47 | 35.18 | 38.55 | 43.11 | 49.79 |
| 1300               | 1.325                                | 1700               | 2600        | 609         |                              | 18.73                | 22.88 | 26.46 | 29.56 | 32.36 | 37.47 | 41.77 | 45.77 | 51.25 | 59.13 |
| 1400               | 1.540                                | 1800               | 2800        | 698         |                              | 21.86                | 26.66 | 30.91 | 34.68 | 37.70 | 43.73 | 48.75 | 53.32 | 60.07 | 69.37 |
| 1500               | 1.765                                | 1900               | 3000        | 851         |                              | 25.04                | 30.75 | 35.60 | 40.02 | 43.48 | 50.09 | 56.58 | 61.50 | 69.37 | 80.03 |

### Note

- The tabulated flow in m<sup>3</sup>/s is based upon tests in the IAC Acoustics R&D Laboratory, in accordance with applicable sections of internationally recognised airflow test codes. These codes require specific lengths of stright duct both upstream and downstream of the test specimen. Non-compliance with these codes can add from 0.5 to several velocity heads depending on specific conditions. The downstream measurements are made far enough downstream to include static regain. Therefore, if silencers are installed immediately before or after elbows, transitions or at the intake or discharge of the system, sufficient allowance to compensate for these factors must be included when calculating the operating static pressure loss through the silencer. See pages 10 and 11 for further details.
- Face Velocity is the airflow (m<sup>3</sup>/s) divided by the Face Area (m<sup>2</sup>)
- Pressure drop for any face velocity can be calculated from the equation:  
 $PD = (\text{Actual FV} / \text{catalogue FV})^2 \times (\text{Catalogue PD})$
- Self Noise values shown are for a 0.37m<sup>2</sup> face area silencer
  - For each doubling of face area add 3dB to the self noise values listed
  - For each halving of face area subtract 3dB from the self noise values listed

# Low Frequency Conic-Flow® Silencer Type: FCL

Low Frequency With Forward and Reverse Flow Ratings

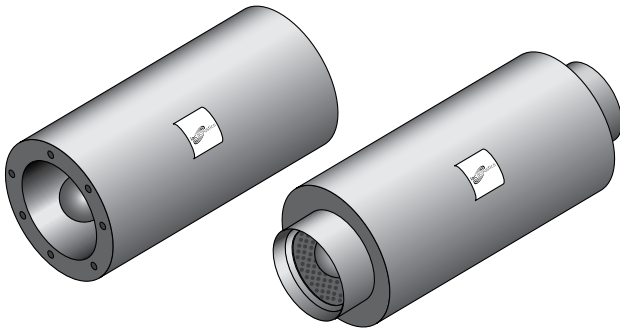

### Supplied as Standard

- Aerodynamic inlet and discharge to splitter elements to reduce pressure drop and conserve energy
- Perforated galvanised steel facings to all splitter elements to protect acoustic media from damage and erosion

### Designating Silencers: Example

Model: 300-FCL-900

| Pipe Diameter | Type | Length |
|---------------|------|--------|
| 300mm         | FCL  | 900mm  |

## Dynamic Insertion Loss (DIL) Ratings: Forward (+) / Reverse (-) Flow

| IAC FCL Model (pipe diameter in mm) | Octave Band                 | 1  | 2   | 3   | 4   | 5  | 6  | 7  | 8  |
|-------------------------------------|-----------------------------|----|-----|-----|-----|----|----|----|----|
|                                     | Hz                          | 63 | 125 | 250 | 500 | 1K | 2K | 4K | 8K |
|                                     | Silencer Face Velocity, m/s |    |     |     |     |    |    |    |    |
| 300-FCL-900                         | -20                         | 8  | 17  | 25  | 30  | 35 | 34 | 23 | 18 |
|                                     | -10                         | 8  | 16  | 23  | 29  | 34 | 34 | 25 | 19 |
|                                     | 0                           | 8  | 15  | 22  | 27  | 33 | 31 | 26 | 21 |
|                                     | +10                         | 8  | 14  | 20  | 25  | 32 | 27 | 26 | 23 |
|                                     | +20                         | 7  | 12  | 18  | 23  | 31 | 29 | 27 | 23 |
| 600-FCL-1200                        | -20                         | 9  | 16  | 26  | 31  | 35 | 21 | 15 | 12 |
|                                     | -10                         | 9  | 15  | 24  | 29  | 33 | 21 | 16 | 13 |
|                                     | 0                           | 8  | 14  | 23  | 28  | 34 | 23 | 19 | 15 |
|                                     | +10                         | 7  | 13  | 21  | 26  | 34 | 25 | 21 | 16 |
|                                     | +20                         | 6  | 12  | 20  | 24  | 32 | 25 | 21 | 17 |
| 900-FCL-1800                        | -20                         | 11 | 20  | 29  | 33  | 30 | 20 | 17 | 12 |
|                                     | -10                         | 10 | 19  | 28  | 33  | 29 | 21 | 18 | 13 |
|                                     | 0                           | 9  | 17  | 26  | 32  | 29 | 23 | 19 | 15 |
|                                     | +10                         | 8  | 15  | 24  | 31  | 29 | 25 | 20 | 16 |
|                                     | +20                         | 7  | 13  | 21  | 26  | 34 | 25 | 21 | 16 |
| 1200-FCL-2400                       | -20                         | 12 | 22  | 33  | 37  | 30 | 17 | 13 | 11 |
|                                     | -10                         | 12 | 20  | 31  | 36  | 30 | 18 | 15 | 13 |
|                                     | 0                           | 11 | 19  | 29  | 35  | 30 | 20 | 17 | 15 |
|                                     | +10                         | 9  | 17  | 27  | 33  | 29 | 22 | 18 | 16 |
|                                     | +20                         | 9  | 16  | 24  | 32  | 28 | 23 | 18 | 17 |
| 1500-FCL-3000                       | -20                         | 15 | 26  | 36  | 38  | 29 | 15 | 11 | 10 |
|                                     | -10                         | 14 | 24  | 34  | 37  | 29 | 16 | 12 | 11 |
|                                     | 0                           | 13 | 22  | 33  | 36  | 28 | 19 | 15 | 14 |
|                                     | +10                         | 11 | 20  | 31  | 35  | 27 | 21 | 17 | 16 |
|                                     | +20                         | 10 | 18  | 28  | 35  | 26 | 20 | 17 | 17 |



## Self-Noise Power Levels dB re: 10<sup>-12</sup> Watts

| IAC FCL Model               | Octave Band                 | 1  | 2   | 3   | 4   | 5  | 6  | 7  | 8  |
|-----------------------------|-----------------------------|----|-----|-----|-----|----|----|----|----|
|                             | Hz                          | 63 | 125 | 250 | 500 | 1K | 2K | 4K | 8K |
|                             | Silencer Face Velocity, m/s |    |     |     |     |    |    |    |    |
| FCL All Pipe Diameters (mm) | -15                         | 56 | 56  | 55  | 56  | 55 | 55 | 50 | 45 |
|                             | -10                         | 47 | 47  | 47  | 47  | 45 | 45 | 37 | 29 |
|                             | -5                          | 31 | 32  | 32  | 31  | 30 | 30 | 20 | 20 |
|                             | +5                          | 39 | 35  | 32  | 32  | 30 | 25 | 20 | 20 |
|                             | +10                         | 52 | 48  | 46  | 46  | 45 | 42 | 39 | 25 |
|                             | +15                         | 60 | 56  | 54  | 54  | 53 | 52 | 50 | 40 |

## Physical and Aerodynamic Performance

| Physical Data      |                                      |                    |             |             | Type | Static Pressure Drop         |       |       |       |       |       |       |       |       |       |  |
|--------------------|--------------------------------------|--------------------|-------------|-------------|------|------------------------------|-------|-------|-------|-------|-------|-------|-------|-------|-------|--|
| Pipe Diameter (mm) | Silencer Face Area (m <sup>2</sup> ) | Body Diameter (mm) | Length (mm) | Weight (kg) | FCL  | 27                           | 39    | 53    | 66    | 80    | 107   | 133   | 159   | 199   | 265   |  |
|                    |                                      |                    |             |             |      | Airflow in m <sup>3</sup> /s |       |       |       |       |       |       |       |       |       |  |
| 300                | 0.070                                | 700                | 900         | 45          |      | 0.84                         | 1.03  | 1.19  | 1.34  | 1.46  | 1.68  | 1.90  | 2.07  | 2.31  | 2.68  |  |
| 350                | 0.095                                | 750                | 900         | 50          |      | 1.16                         | 1.42  | 1.64  | 1.85  | 2.02  | 2.32  | 2.61  | 2.85  | 3.2   | 3.69  |  |
| 400                | 0.125                                | 800                | 900         | 60          |      | 1.55                         | 1.90  | 2.19  | 2.46  | 2.70  | 3.10  | 3.48  | 3.80  | 4.26  | 4.92  |  |
| 450                | 0.160                                | 850                | 900         | 68          |      | 2.03                         | 2.49  | 2.88  | 3.21  | 3.53  | 4.07  | 4.55  | 4.98  | 6.09  | 6.82  |  |
| 500                | 0.195                                | 900                | 1000        | 76          |      | 2.52                         | 2.94  | 3.56  | 3.97  | 4.35  | 5.04  | 5.63  | 6.16  | 6.89  | 7.95  |  |
| 600                | 0.240                                | 950                | 1100        | 85          |      | 3.11                         | 3.81  | 4.39  | 4.93  | 5.37  | 6.21  | 6.96  | 7.62  | 8.53  | 9.86  |  |
| 600                | 0.285                                | 1000               | 1200        | 95          |      | 3.75                         | 4.60  | 5.31  | 5.95  | 6.51  | 7.50  | 8.40  | 9.20  | 10.26 | 11.89 |  |
| 650                | 0.330                                | 1050               | 1300        | 106         |      | 4.43                         | 5.41  | 6.26  | 7.00  | 7.64  | 8.84  | 9.91  | 10.86 | 12.19 | 14.02 |  |
| 700                | 0.385                                | 1100               | 1400        | 116         |      | 5.16                         | 6.30  | 7.27  | 8.20  | 8.91  | 10.31 | 11.60 | 12.60 | 14.26 | 16.40 |  |
| 750                | 0.440                                | 1150               | 1500        | 170         |      | 5.91                         | 7.24  | 8.36  | 9.32  | 10.25 | 11.82 | 12.98 | 14.49 | 16.21 | 18.64 |  |
| 800                | 0.500                                | 1200               | 1600        | 225         |      | 6.78                         | 8.29  | 9.58  | 10.78 | 11.76 | 13.55 | 15.24 | 16.57 | 18.68 | 21.56 |  |
| 900                | 0.635                                | 1300               | 1800        | 273         |      | 8.62                         | 10.57 | 12.17 | 13.72 | 14.95 | 17.23 | 19.40 | 21.13 | 23.78 | 27.44 |  |
| 1000               | 0.785                                | 1400               | 2000        | 340         |      | 10.74                        | 13.12 | 15.17 | 17.06 | 18.57 | 21.48 | 24.13 | 26.25 | 29.65 | 34.12 |  |
| 1100               | 0.950                                | 1500               | 2200        | 432         |      | 13.13                        | 16.07 | 18.55 | 20.86 | 22.72 | 26.26 | 29.50 | 32.15 | 36.07 | 41.72 |  |
| 1200               | 1.130                                | 1600               | 2400        | 518         |      | 15.73                        | 19.27 | 22.25 | 24.90 | 27.25 | 31.47 | 35.18 | 38.55 | 43.11 | 49.79 |  |
| 1300               | 1.325                                | 1700               | 2600        | 609         |      | 18.73                        | 22.88 | 26.46 | 29.56 | 32.36 | 37.47 | 41.77 | 45.77 | 51.25 | 59.13 |  |
| 1400               | 1.540                                | 1800               | 2800        | 698         |      | 21.86                        | 26.66 | 30.91 | 34.68 | 37.70 | 43.73 | 48.75 | 53.32 | 60.07 | 69.37 |  |
| 1500               | 1.765                                | 1900               | 3000        | 851         |      | 25.04                        | 30.75 | 35.60 | 40.02 | 43.48 | 50.09 | 56.58 | 61.50 | 69.37 | 80.03 |  |

### Note

- The tabulated flow in m<sup>3</sup>/s is based upon tests in the IAC Acoustics R&D Laboratory, in accordance with applicable sections of internationally recognised airflow test codes. These codes require specific lengths of stright duct both upstream and downstream of the test specimen. Non-compliance with these codes can add from 0.5 to several velocity heads depending on specific conditions. The downstream measurements are made far enough downstream to include static regain. Therefore, if silencers are installed immediately before or after elbows, transitions or at the intake or discharge of the system, sufficient allowance to compensate for these factors must be included when calculating the operating static pressure loss through the silencer. See pages 10 and 11 for further details.
- Face Velocity is the airflow (m<sup>3</sup>/s) divided by the Face Area (m<sup>2</sup>)
- Pressure drop for any face velocity can be calculated from the equation:  
 $PD = (\text{Actual FV} / \text{catalogue FV})^2 \times (\text{Catalogue PD})$
- Self Noise values shown are for a 0.37m<sup>2</sup> face area silencer
  - For each doubling of face area add 3dB to the self noise values listed
  - For each halving of face area subtract 3dB from the self noise values listed

# Conic-Flow® Silencer Type: NS

With Forward and Reverse Flow Ratings

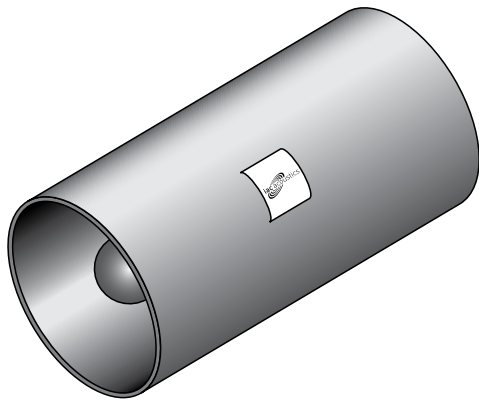

## Supplied as Standard

- Aerodynamic inlet and discharge to splitter elements to reduce pressure drop and conserve energy
- Perforated galvanised steel facings to all splitter elements to protect acoustic media from damage and erosion

## Designating Silencers: Example

Model: 300-NS-1000

| Pipe Diameter | Type | Length |
|---------------|------|--------|
| 300mm         | NS   | 1000mm |

## Dynamic Insertion Loss (DIL) Ratings: Forward (+) / Reverse (-) Flow

| IAC NS Model (pipe diameter in mm) | Octave Band                 | 1  | 2   | 3   | 4   | 5  | 6  | 7  | 8  |
|------------------------------------|-----------------------------|----|-----|-----|-----|----|----|----|----|
|                                    | Hz                          | 63 | 125 | 250 | 500 | 1K | 2K | 4K | 8K |
|                                    | Silencer Face Velocity, m/s |    |     |     |     |    |    |    |    |
| 300-NS-1000                        | -20                         | 3  | 4   | 9   | 15  | 24 | 21 | 13 | 8  |
|                                    | -10                         | 3  | 4   | 9   | 14  | 24 | 21 | 13 | 8  |
|                                    | 0                           | 3  | 4   | 9   | 14  | 22 | 21 | 14 | 10 |
|                                    | +10                         | 3  | 4   | 9   | 14  | 19 | 21 | 14 | 12 |
|                                    | +20                         | 3  | 4   | 9   | 14  | 17 | 21 | 14 | 12 |
| 600-NS-1950                        | -20                         | 4  | 11  | 16  | 22  | 25 | 19 | 11 | 10 |
|                                    | -10                         | 4  | 10  | 15  | 20  | 24 | 21 | 12 | 11 |
|                                    | 0                           | 4  | 10  | 15  | 19  | 24 | 21 | 12 | 12 |
|                                    | +10                         | 4  | 10  | 14  | 18  | 23 | 21 | 12 | 12 |
|                                    | +20                         | 4  | 9   | 13  | 17  | 23 | 21 | 12 | 12 |
| 900-NS-2950                        | -20                         | 6  | 13  | 17  | 23  | 23 | 15 | 10 | 8  |
|                                    | -10                         | 6  | 13  | 17  | 22  | 23 | 16 | 11 | 9  |
|                                    | 0                           | 6  | 13  | 17  | 21  | 23 | 17 | 11 | 10 |
|                                    | +10                         | 6  | 13  | 17  | 20  | 22 | 17 | 11 | 10 |
|                                    | +20                         | 6  | 12  | 16  | 19  | 22 | 17 | 11 | 10 |
| 1200-NS-3900                       | -20                         | 7  | 15  | 19  | 25  | 22 | 11 | 9  | 7  |
|                                    | -10                         | 7  | 15  | 19  | 23  | 20 | 12 | 10 | 8  |
|                                    | 0                           | 7  | 15  | 19  | 23  | 20 | 12 | 10 | 8  |
|                                    | +10                         | 7  | 15  | 19  | 23  | 20 | 12 | 10 | 8  |
|                                    | +20                         | 7  | 15  | 19  | 22  | 20 | 12 | 10 | 8  |
| 1500-NS-4900                       | -20                         | 10 | 17  | 21  | 23  | 19 | 8  | 7  | 6  |
|                                    | -10                         | 10 | 17  | 20  | 23  | 18 | 9  | 8  | 7  |
|                                    | 0                           | 10 | 17  | 20  | 23  | 18 | 10 | 9  | 8  |
|                                    | +10                         | 10 | 17  | 20  | 22  | 17 | 10 | 9  | 8  |
|                                    | +20                         | 9  | 16  | 19  | 22  | 17 | 10 | 10 | 9  |

## Self-Noise Power Levels dB re: 10<sup>-12</sup> Watts

| IAC NS Model               | Octave Band                 | 1  | 2   | 3   | 4   | 5  | 6  | 7  | 8  |
|----------------------------|-----------------------------|----|-----|-----|-----|----|----|----|----|
|                            | Hz                          | 63 | 125 | 250 | 500 | 1K | 2K | 4K | 8K |
|                            | Silencer Face Velocity, m/s |    |     |     |     |    |    |    |    |
| NS All Pipe Diameters (mm) | -15                         | 59 | 56  | 55  | 57  | 57 | 59 | 55 | 50 |
|                            | -10                         | 51 | 48  | 47  | 48  | 49 | 51 | 44 | 36 |
|                            | -5                          | 37 | 34  | 33  | 33  | 35 | 38 | 26 | 20 |
|                            | +5                          | 44 | 37  | 33  | 32  | 35 | 31 | 20 | 20 |
|                            | +10                         | 56 | 48  | 45  | 45  | 47 | 46 | 38 | 28 |
|                            | +15                         | 63 | 54  | 52  | 53  | 54 | 55 | 50 | 43 |

## Physical and Aerodynamic Performance

| Physical Data      |                                      |             |             | Type                         | Static Pressure Drop, N/m <sup>2</sup> |       |       |       |       |       |       |       |       |       |  |  |
|--------------------|--------------------------------------|-------------|-------------|------------------------------|--|-------|-------|-------|-------|-------|-------|-------|-------|-------|--|--|
| Pipe Diameter (mm) | Silencer Face Area (m <sup>2</sup> ) | Length (mm) | Weight (kg) | NS                           | 53                                     | 80    | 107   | 133   | 159   | 212   | 265   | 319   | 398   | -     |  |  |
|                    |                                      |             |             | Airflow in m <sup>3</sup> /s |  |       |       |       |       |       |       |       |       |       |  |  |
| 300                | 0.070                                | 1000        | 18          |                              | 0.65                                   | 0.80  | 0.92  | 1.03  | 1.13  | 1.30  | 1.45  | 1.59  | 1.78  | 2.07  |  |  |
| 350                | 0.095                                | 1150        | 25          |                              | 0.89                                   | 1.10  | 1.27  | 1.42  | 1.55  | 1.79  | 2.01  | 2.19  | 2.45  | 2.83  |  |  |
| 400                | 0.125                                | 1300        | 34          |                              | 1.20                                   | 1.47  | 1.69  | 1.89  | 2.07  | 2.40  | 2.68  | 2.94  | 3.28  | 3.78  |  |  |
| 450                | 0.160                                | 1450        | 43          |                              | 1.56                                   | 1.91  | 2.21  | 2.47  | 2.71  | 3.12  | 3.50  | 3.83  | 4.28  | 4.94  |  |  |
| 500                | 0.195                                | 1600        | 50          |                              | 1.94                                   | 2.38  | 2.75  | 3.08  | 3.37  | 3.89  | 4.35  | 4.76  | 5.33  | 6.15  |  |  |
| 600                | 0.240                                | 1800        | 57          |                              | 2.41                                   | 2.95  | 3.40  | 3.80  | 4.16  | 4.81  | 5.37  | 5.89  | 6.59  | 7.61  |  |  |
| 600                | 0.285                                | 1950        | 64          |                              | 2.89                                   | 3.54  | 4.09  | 4.57  | 5.00  | 5.78  | 6.47  | 7.08  | 7.90  | 9.14  |  |  |
| 650                | 0.330                                | 2100        | 91          |                              | 3.41                                   | 4.18  | 4.84  | 5.41  | 5.90  | 6.82  | 7.64  | 8.35  | 9.34  | 10.82 |  |  |
| 700                | 0.385                                | 2250        | 116         |                              | 3.96                                   | 4.84  | 5.61  | 6.28  | 6.84  | 7.93  | 8.87  | 9.67  | 10.86 | 12.55 |  |  |
| 750                | 0.440                                | 2450        | 141         |                              | 4.56                                   | 5.60  | 6.46  | 7.22  | 7.91  | 9.12  | 10.20 | 11.20 | 12.49 | 14.44 |  |  |
| 800                | 0.500                                | 2600        | 166         |                              | 5.22                                   | 6.39  | 7.38  | 8.26  | 9.05  | 10.44 | 11.69 | 12.79 | 14.30 | 16.52 |  |  |
| 900                | 0.635                                | 2950        | 193         |                              | 6.64                                   | 8.14  | 9.39  | 10.50 | 11.48 | 13.29 | 14.85 | 16.27 | 18.17 | 20.99 |  |  |
| 1000               | 0.785                                | 3250        | 218         |                              | 8.26                                   | 10.14 | 11.71 | 13.07 | 14.31 | 16.53 | 18.48 | 20.27 | 22.65 | 26.14 |  |  |
| 1100               | 0.950                                | 3600        | 257         |                              | 10.11                                  | 12.39 | 14.28 | 15.97 | 17.50 | 20.22 | 22.59 | 24.78 | 27.65 | 31.95 |  |  |
| 1200               | 1.130                                | 3900        | 295         |                              | 12.14                                  | 14.86 | 17.17 | 19.21 | 21.03 | 24.27 | 27.18 | 29.73 | 33.25 | 38.41 |  |  |
| 1300               | 1.325                                | 4250        | 336         |                              | 14.38                                  | 17.63 | 20.36 | 22.76 | 24.93 | 28.77 | 32.19 | 35.26 | 39.39 | 45.52 |  |  |
| 1400               | 1.540                                | 4550        | 536         |                              | 16.76                                  | 20.60 | 23.69 | 26.58 | 29.15 | 33.52 | 37.60 | 41.21 | 45.85 | 53.17 |  |  |
| 1500               | 1.765                                | 4900        | 745         |                              | 19.31                                  | 23.69 | 27.30 | 30.55 | 33.50 | 38.62 | 43.20 | 47.38 | 52.90 | 61.10 |  |  |

### Note

- The tabulated flow in m<sup>3</sup>/s is based upon tests in the IAC Acoustics R&D Laboratory, in accordance with applicable sections of internationally recognised airflow test codes. These codes require specific lengths of stright duct both upstream and downstream of the test specimen. Non-compliance with these codes can add from 0.5 to several velocity heads depending on specific conditions. The downstream measurements are made far enough downstream to include static regain. Therefore, if silencers are installed immediately before or after elbows, transitions or at the intake or discharge of the system, sufficient allowance to compensate for these factors must be included when calculating the operating static pressure loss through the silencer. See pages 10 and 11 for further details.
- Face Velocity is the airflow (m<sup>3</sup>/s) divided by the Face Area (m<sup>2</sup>)
- Pressure drop for any face velocity can be calculated from the equation:  
 $PD = (\text{Actual FV} / \text{catalogue FV})^2 \times (\text{Catalogue PD})$
- Self Noise values shown are for a 0.37m<sup>2</sup> face area silencer
  - For each doubling of face area add 3dB to the self noise values listed
  - For each halving of face area subtract 3dB from the self noise values listed

# Conic-Flow® Silencer Type: NL

With Forward and Reverse Flow Ratings

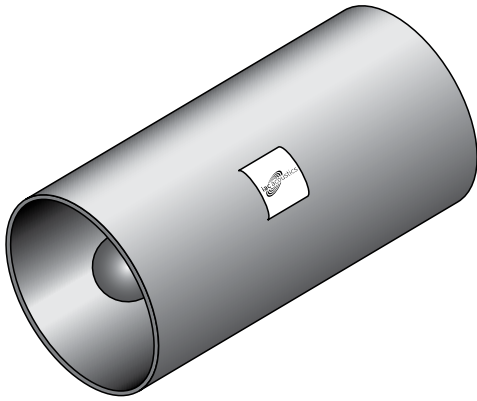

## Supplied as Standard

- Aerodynamic inlet and discharge to splitter elements to reduce pressure drop and conserve energy
- Perforated galvanised steel facings to all splitter elements to protect acoustic media from damage and erosion

## Designating Silencers: Example

Model: 300-NL-1000

| Pipe Diameter | Type | Length |
|---------------|------|--------|
| 300mm         | NL   | 1000mm |

## Dynamic Insertion Loss (DIL) Ratings: Forward (+) / Reverse (-) Flow

| IAC NL Model (pipe diameter in mm) | Octave Band                 | 1  | 2   | 3   | 4   | 5  | 6  | 7  | 8  |
|------------------------------------|-----------------------------|----|-----|-----|-----|----|----|----|----|
|                                    | Hz                          | 63 | 125 | 250 | 500 | 1K | 2K | 4K | 8K |
|                                    | Silencer Face Velocity, m/s |    |     |     |     |    |    |    |    |
| 300-NL-1000                        | -20                         | 2  | 5   | 10  | 11  | 17 | 15 | 9  | 8  |
|                                    | -10                         | 1  | 3   | 9   | 11  | 16 | 15 | 9  | 9  |
|                                    | 0                           | 1  | 3   | 9   | 11  | 16 | 15 | 10 | 10 |
|                                    | +10                         | 1  | 3   | 9   | 11  | 15 | 15 | 10 | 10 |
|                                    | +20                         | 1  | 3   | 8   | 10  | 14 | 15 | 10 | 10 |
| 600-NL-1950                        | -20                         | 5  | 11  | 14  | 17  | 18 | 14 | 10 | 8  |
|                                    | -10                         | 3  | 10  | 12  | 16  | 17 | 14 | 10 | 9  |
|                                    | 0                           | 3  | 10  | 12  | 16  | 17 | 14 | 11 | 10 |
|                                    | +10                         | 3  | 9   | 11  | 15  | 16 | 14 | 11 | 10 |
|                                    | +20                         | 3  | 9   | 11  | 15  | 16 | 14 | 11 | 10 |
| 900-NL-2950                        | -20                         | 6  | 12  | 16  | 18  | 16 | 12 | 9  | 6  |
|                                    | -10                         | 4  | 11  | 14  | 17  | 15 | 12 | 9  | 7  |
|                                    | 0                           | 4  | 11  | 14  | 17  | 15 | 12 | 10 | 8  |
|                                    | +10                         | 10 | 13  | 16  | 15  | 12 | 10 | 8  | 6  |
|                                    | +20                         | 4  | 10  | 13  | 16  | 15 | 13 | 11 | 8  |
| 1200-NL-3900                       | -20                         | 8  | 13  | 18  | 17  | 14 | 10 | 8  | 4  |
|                                    | -10                         | 5  | 11  | 16  | 16  | 14 | 10 | 9  | 6  |
|                                    | 0                           | 5  | 11  | 16  | 16  | 14 | 11 | 9  | 7  |
|                                    | +10                         | 5  | 11  | 15  | 15  | 14 | 11 | 9  | 7  |
|                                    | +20                         | 5  | 11  | 15  | 15  | 14 | 11 | 10 | 7  |
| 1500-NL-4900                       | -20                         | 10 | 14  | 18  | 17  | 11 | 9  | 6  | 4  |
|                                    | -10                         | 7  | 13  | 16  | 16  | 11 | 9  | 7  | 5  |
|                                    | 0                           | 7  | 13  | 16  | 16  | 11 | 10 | 7  | 6  |
|                                    | +10                         | 7  | 13  | 15  | 15  | 11 | 10 | 7  | 6  |
|                                    | +20                         | 7  | 13  | 15  | 15  | 11 | 10 | 8  | 7  |

## Self-Noise Power Levels dB re: 10<sup>-12</sup> Watts

| IAC NL Model               | Octave Band                 | 1  | 2   | 3   | 4   | 5  | 6  | 7  | 8  |
|----------------------------|-----------------------------|----|-----|-----|-----|----|----|----|----|
|                            | Hz                          | 63 | 125 | 250 | 500 | 1K | 2K | 4K | 8K |
|                            | Silencer Face Velocity, m/s |    |     |     |     |    |    |    |    |
| NL All Pipe Diameters (mm) | -15                         | 60 | 59  | 59  | 58  | 59 | 58 | 53 | 43 |
|                            | -10                         | 53 | 51  | 51  | 51  | 51 | 50 | 41 | 32 |
|                            | -5                          | 40 | 38  | 38  | 38  | 38 | 36 | 20 | 20 |
|                            | +5                          | 39 | 35  | 32  | 32  | 30 | 25 | 21 | 20 |
|                            | +10                         | 52 | 48  | 46  | 46  | 45 | 42 | 39 | 26 |
|                            | +15                         | 59 | 56  | 54  | 54  | 53 | 52 | 50 | 40 |

## Physical and Aerodynamic Performance

| Physical Data      |                                      |             |             | Type | Static Pressure Drop, N/m <sup>2</sup> |       |       |       |       |       |       |       |       |       |  |
|--------------------|--------------------------------------|-------------|-------------|------|--|-------|-------|-------|-------|-------|-------|-------|-------|-------|--|
| Pipe Diameter (mm) | Silencer Face Area (m <sup>2</sup> ) | Length (mm) | Weight (kg) | NL   | 27                                     | 39    | 53    | 66    | 80    | 107   | 133   | 159   | 199   | 265   |  |
|                    |                                      |             |             |      | Airflow in m <sup>3</sup> /s           |       |       |       |       |       |       |       |       |       |  |
| 300                | 0.070                                | 1000        | 18          |      | 0.65                                   | 0.80  | 0.92  | 1.03  | 1.13  | 1.30  | 1.45  | 1.59  | 1.78  | 2.07  |  |
| 350                | 0.095                                | 1150        | 25          |      | 0.89                                   | 1.10  | 1.27  | 1.42  | 1.55  | 1.79  | 2.01  | 2.19  | 2.45  | 2.83  |  |
| 400                | 0.125                                | 1300        | 34          |      | 1.20                                   | 1.47  | 1.69  | 1.89  | 2.07  | 2.40  | 2.68  | 2.94  | 3.28  | 3.78  |  |
| 450                | 0.160                                | 1450        | 43          |      | 1.56                                   | 1.91  | 2.21  | 2.47  | 2.71  | 3.12  | 3.50  | 3.83  | 4.28  | 4.94  |  |
| 500                | 0.195                                | 1600        | 50          |      | 1.94                                   | 2.38  | 2.75  | 3.08  | 3.37  | 3.89  | 4.35  | 4.76  | 5.33  | 6.15  |  |
| 600                | 0.240                                | 1800        | 57          |      | 2.41                                   | 2.95  | 3.40  | 3.80  | 4.16  | 4.81  | 5.37  | 5.89  | 6.59  | 7.61  |  |
| 600                | 0.285                                | 1950        | 64          |      | 2.89                                   | 3.54  | 4.09  | 4.57  | 5.00  | 5.78  | 6.47  | 7.08  | 7.90  | 9.14  |  |
| 650                | 0.330                                | 2100        | 91          |      | 3.41                                   | 4.18  | 4.84  | 5.41  | 5.90  | 6.82  | 7.64  | 8.35  | 9.34  | 10.82 |  |
| 700                | 0.385                                | 2250        | 116         |      | 3.96                                   | 4.84  | 5.61  | 6.28  | 6.84  | 7.93  | 8.87  | 9.67  | 10.86 | 12.55 |  |
| 750                | 0.440                                | 2450        | 141         |      | 4.56                                   | 5.60  | 6.46  | 7.22  | 7.91  | 9.12  | 10.20 | 11.20 | 12.49 | 14.44 |  |
| 800                | 0.500                                | 2600        | 166         |      | 5.22                                   | 6.39  | 7.38  | 8.26  | 9.05  | 10.44 | 11.69 | 12.79 | 14.30 | 16.52 |  |
| 900                | 0.635                                | 2950        | 193         |      | 6.64                                   | 8.14  | 9.39  | 10.50 | 11.48 | 13.29 | 14.85 | 16.27 | 18.17 | 20.99 |  |
| 1000               | 0.785                                | 3250        | 218         |      | 8.26                                   | 10.14 | 11.71 | 13.07 | 14.31 | 16.53 | 18.48 | 20.27 | 22.65 | 26.14 |  |
| 1100               | 0.950                                | 3600        | 257         |      | 10.11                                  | 12.39 | 14.28 | 15.97 | 17.50 | 20.22 | 22.59 | 24.78 | 27.65 | 31.95 |  |
| 1200               | 1.130                                | 3900        | 295         |      | 12.14                                  | 14.86 | 17.17 | 19.21 | 21.03 | 24.27 | 27.18 | 29.73 | 33.25 | 38.41 |  |
| 1300               | 1.325                                | 4250        | 336         |      | 14.38                                  | 17.63 | 20.36 | 22.76 | 24.93 | 28.77 | 32.19 | 35.26 | 39.39 | 45.52 |  |
| 1400               | 1.540                                | 4550        | 536         |      | 16.76                                  | 20.60 | 23.69 | 26.58 | 29.15 | 33.52 | 37.60 | 41.21 | 45.85 | 53.17 |  |
| 1500               | 1.765                                | 4900        | 745         |      | 19.31                                  | 23.69 | 27.30 | 30.55 | 33.50 | 38.62 | 43.20 | 47.38 | 52.90 | 61.10 |  |

### Note

- The tabulated flow in m<sup>3</sup>/s is based upon tests in the IAC Acoustics R&D Laboratory, in accordance with applicable sections of internationally recognised airflow test codes. These codes require specific lengths of stright duct both upstream and downstream of the test specimen. Non-compliance with these codes can add from 0.5 to several velocity heads depending on specific conditions. The downstream measurements are made far enough downstream to include static regain. Therefore, if silencers are installed immediately before or after elbows, transitions or at the intake or discharge of the system, sufficient allowance to compensate for these factors must be included when calculating the operating static pressure loss through the silencer. See pages 10 and 11 for further details.
- Face Velocity is the airflow (m<sup>3</sup>/s) divided by the Face Area (m<sup>2</sup>)
- Pressure drop for any face velocity can be calculated from the equation:  
 $PD = (\text{Actual FV} / \text{catalogue FV})^2 \times (\text{Catalogue PD})$
- Self Noise values shown are for a 0.37m<sup>2</sup> face area silencer
  - For each doubling of face area add 3dB to the self noise values listed
  - For each halving of face area subtract 3dB from the self noise values listed

# Un-Podded Conic Flow® Silencer Type: C

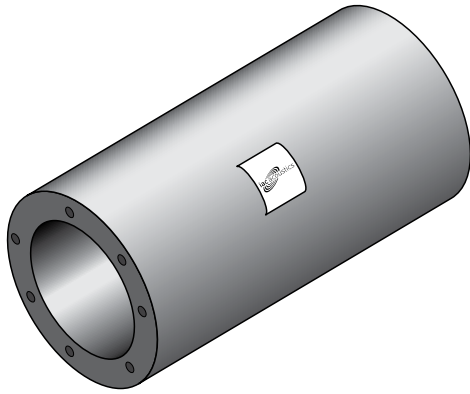

### Supplied as Standard

- Aerodynamic inlet and discharge to splitter elements to reduce pressure drop and conserve energy
- Perforated galvanised steel facings to all splitter elements to protect acoustic media from damage and erosion

### Designating Silencers: Example

Model: 160-C2-900

| Pipe Diameter | Type | Length |
|---------------|------|--------|
| 160mm         | C2   | 900mm  |

## Dynamic Insertion Loss (DIL) C2 Model - 50mm Insulation

| Nominal Diameter (mm) | Internal Diameter (mm) | Outside Diameter (mm) | Length (mm) | Octave Band | 1  | 2   | 3   | 4   | 5  | 6  | 7  | 8  |
|-----------------------|------------------------|-----------------------|-------------|-------------|----|-----|-----|-----|----|----|----|----|
|                       |                        |                       |             | Hz          | 63 | 125 | 250 | 500 | 1K | 2K | 4K | 8K |
| 80                    | 79                     | 180                   | 300         |             | 4  | 6   | 11  | 13  | 29 | 35 | 33 | 18 |
| 80                    | 79                     | 180                   | 600         |             | 4  | 8   | 15  | 27  | 45 | 50 | 50 | 28 |
| 80                    | 79                     | 180                   | 900         |             | 5  | 10  | 19  | 35  | 50 | 50 | 50 | 34 |
| 80                    | 79                     | 180                   | 1200        |             | 5  | 12  | 22  | 42  | 50 | 50 | 50 | 40 |
| 100                   | 99                     | 200                   | 300         |             | 3  | 5   | 8   | 14  | 19 | 24 | 30 | 18 |
| 100                   | 99                     | 200                   | 600         |             | 4  | 7   | 12  | 26  | 34 | 45 | 50 | 29 |
| 100                   | 99                     | 200                   | 900         |             | 4  | 9   | 16  | 34  | 45 | 50 | 50 | 34 |
| 100                   | 99                     | 200                   | 1200        |             | 6  | 12  | 22  | 41  | 50 | 50 | 50 | 41 |
| 125                   | 124                    | 225                   | 300         |             | 3  | 4   | 6   | 12  | 16 | 20 | 20 | 14 |
| 125                   | 124                    | 225                   | 600         |             | 4  | 5   | 11  | 20  | 30 | 36 | 38 | 23 |
| 125                   | 124                    | 225                   | 900         |             | 4  | 7   | 14  | 28  | 42 | 45 | 44 | 26 |
| 125                   | 124                    | 225                   | 1200        |             | 4  | 9   | 17  | 35  | 47 | 50 | 60 | 30 |
| 160                   | 159                    | 260                   | 300         |             | 2  | 3   | 5   | 10  | 11 | 16 | 16 | 11 |
| 160                   | 159                    | 260                   | 600         |             | 3  | 4   | 7   | 18  | 26 | 34 | 30 | 15 |
| 160                   | 159                    | 260                   | 900         |             | 4  | 5   | 10  | 27  | 36 | 45 | 38 | 19 |
| 160                   | 159                    | 260                   | 1200        |             | 5  | 6   | 13  | 34  | 43 | 50 | 46 | 23 |
| 200                   | 199                    | 300                   | 300         |             | 2  | 3   | 4   | 8   | 10 | 14 | 13 | 10 |
| 200                   | 199                    | 300                   | 600         |             | 3  | 4   | 7   | 14  | 16 | 18 | 15 | 14 |
| 200                   | 199                    | 300                   | 900         |             | 4  | 4   | 9   | 18  | 22 | 23 | 17 | 16 |
| 200                   | 199                    | 300                   | 1200        |             | 4  | 5   | 10  | 20  | 28 | 27 | 20 | 18 |
| 250                   | 249                    | 350                   | 300         |             | 2  | 3   | 4   | 9   | 15 | 12 | 11 | 10 |
| 250                   | 249                    | 350                   | 600         |             | 2  | 3   | 6   | 13  | 19 | 17 | 15 | 14 |
| 250                   | 249                    | 350                   | 900         |             | 3  | 4   | 8   | 15  | 22 | 21 | 17 | 16 |
| 250                   | 249                    | 350                   | 1200        |             | 3  | 5   | 10  | 17  | 25 | 24 | 20 | 19 |
| 315                   | 314                    | 415                   | 600         |             | 1  | 2   | 6   | 11  | 15 | 13 | 10 | 8  |
| 315                   | 314                    | 415                   | 900         |             | 2  | 4   | 9   | 17  | 20 | 16 | 12 | 11 |
| 315                   | 314                    | 415                   | 1200        |             | 2  | 4   | 11  | 24  | 25 | 19 | 14 | 13 |
| 400                   | 399                    | 500                   | 600         |             | 1  | 3   | 4   | 7   | 11 | 10 | 8  | 8  |
| 400                   | 399                    | 500                   | 900         |             | 2  | 4   | 8   | 12  | 14 | 13 | 11 | 10 |
| 400                   | 399                    | 500                   | 1200        |             | 3  | 5   | 10  | 17  | 17 | 16 | 13 | 12 |

## Dynamic Insertion Loss (DIL) C4 Model - 100mm Insulation

| Nominal Diameter (mm) | Internal Diameter (mm) | Outside Diameter (mm) | Length (mm) | Octave Band | 1  | 2   | 3   | 4   | 5  | 6  | 7  | 8  |
|-----------------------|------------------------|-----------------------|-------------|-------------|----|-----|-----|-----|----|----|----|----|
|                       |                        |                       |             | Hz          | 63 | 125 | 250 | 500 | 1K | 2K | 4K | 8K |
| 80                    | 79                     | 280                   | 600         |             | 8  | 13  | 18  | 27  | 46 | 50 | 50 | 28 |
| 80                    | 79                     | 280                   | 900         |             | 10 | 16  | 28  | 37  | 50 | 50 | 50 | 34 |
| 80                    | 79                     | 280                   | 1200        |             | 12 | 19  | 31  | 48  | 50 | 50 | 50 | 42 |
| 100                   | 99                     | 300                   | 300         |             | 6  | 9   | 11  | 14  | 18 | 23 | 30 | 18 |
| 100                   | 99                     | 300                   | 600         |             | 8  | 13  | 17  | 26  | 35 | 46 | 50 | 29 |
| 100                   | 99                     | 300                   | 900         |             | 10 | 16  | 27  | 36  | 45 | 50 | 50 | 33 |
| 100                   | 99                     | 300                   | 1200        |             | 11 | 19  | 30  | 48  | 50 | 50 | 50 | 42 |
| 125                   | 124                    | 325                   | 300         |             | 5  | 7   | 9   | 11  | 14 | 19 | 20 | 15 |
| 125                   | 124                    | 325                   | 600         |             | 7  | 9   | 17  | 21  | 29 | 35 | 39 | 22 |
| 125                   | 124                    | 325                   | 900         |             | 9  | 12  | 24  | 32  | 41 | 46 | 44 | 26 |
| 125                   | 124                    | 325                   | 1200        |             | 10 | 15  | 29  | 40  | 50 | 50 | 50 | 30 |
| 160                   | 159                    | 360                   | 300         |             | 4  | 5   | 10  | 10  | 12 | 16 | 15 | 11 |
| 160                   | 159                    | 360                   | 600         |             | 6  | 8   | 16  | 18  | 26 | 32 | 29 | 15 |
| 160                   | 159                    | 360                   | 900         |             | 7  | 11  | 22  | 27  | 36 | 45 | 37 | 19 |
| 160                   | 159                    | 360                   | 1200        |             | 8  | 14  | 28  | 33  | 43 | 50 | 46 | 23 |
| 200                   | 199                    | 400                   | 300         |             | 3  | 5   | 8   | 10  | 19 | 14 | 13 | 10 |
| 200                   | 199                    | 400                   | 600         |             | 4  | 7   | 12  | 18  | 27 | 24 | 15 | 14 |
| 200                   | 199                    | 400                   | 900         |             | 5  | 11  | 17  | 27  | 33 | 32 | 18 | 16 |
| 200                   | 199                    | 400                   | 1200        |             | 6  | 14  | 23  | 31  | 39 | 38 | 21 | 19 |
| 250                   | 249                    | 450                   | 300         |             | 3  | 5   | 7   | 10  | 16 | 14 | 12 | 10 |
| 250                   | 249                    | 450                   | 600         |             | 4  | 6   | 11  | 18  | 23 | 19 | 16 | 15 |
| 250                   | 249                    | 450                   | 900         |             | 5  | 9   | 16  | 25  | 30 | 24 | 18 | 17 |
| 250                   | 249                    | 450                   | 1200        |             | 5  | 12  | 20  | 30  | 36 | 30 | 21 | 19 |
| 315                   | 314                    | 515                   | 600         |             | 2  | 4   | 10  | 14  | 17 | 10 | 9  | 8  |
| 315                   | 314                    | 515                   | 900         |             | 3  | 7   | 13  | 24  | 28 | 15 | 12 | 11 |
| 315                   | 314                    | 515                   | 1200        |             | 5  | 10  | 16  | 30  | 34 | 19 | 14 | 13 |
| 400                   | 399                    | 600                   | 600         |             | 2  | 3   | 6   | 11  | 13 | 10 | 8  | 8  |
| 400                   | 399                    | 600                   | 900         |             | 3  | 5   | 11  | 19  | 20 | 15 | 9  | 10 |
| 400                   | 399                    | 600                   | 1200        |             | 3  | 6   | 14  | 24  | 27 | 19 | 12 | 12 |
| 500                   | 499                    | 700                   | 900         |             | 2  | 4   | 6   | 9   | 11 | 10 | 8  | 8  |
| 500                   | 499                    | 700                   | 1200        |             | 3  | 6   | 9   | 12  | 13 | 12 | 10 | 10 |
| 630                   | 629                    | 830                   | 900         |             | 1  | 3   | 5   | 8   | 10 | 7  | 5  | 4  |
| 630                   | 629                    | 830                   | 1200        |             | 2  | 3   | 6   | 12  | 13 | 10 | 7  | 6  |
| 800                   | 799                    | 1000                  | 900         |             | 1  | 1   | 3   | 7   | 8  | 8  | 5  | 4  |
| 800                   | 799                    | 1000                  | 1200        |             | 1  | 2   | 5   | 10  | 11 | 10 | 7  | 6  |

### Note

- The pressure drop through an Un-Podded silencer is negligible
- Self-Noise produced by an Un-Podded silencer is negligible

# Specifications:

## Low Frequency Clean-Flow™ Silencers

The Clean-Flow™ Quiet-Duct® Attenuators from IAC provide superior low frequency attenuation for air handling systems requiring a high degree of cleanliness and hygiene. Acoustic fill is totally encapsulated within the silencer to prevent erosion or entrainment of particulate. A honeycomb acoustic standoff provides additional protection and performance.

### General

Furnish and install factory prefabricated silencers of the types and sizes shown on the plans and/or listed in the schedule. Silencers shall be 'Clean-Flow™' type as manufactured by Industrial Acoustic Company or approved equal. Any change or exception to this specification must be submitted and approved in writing by the Architect/Engineer at least 10 days before the bid date.

### Materials

Outer casings of rectangular silencer modules shall be made of 22 gauge type (0.8mm) lock former quality galvanised steel. Interior partitions for rectangular silencer modules shall be not less than 26 gauge type (0.46mm) galvanised lock former quality perforated steel. Filler material shall be of inorganic mineral glass fibre of a proper density to obtain the specified acoustic performance

and be packed under not less than 5% compression to eliminate voids due to vibration and settling. Material shall be inert, vermin and moisture proof. Filler material shall be totally encapsulated and sealed with mylar or Melinex film of an approximate thickness of 38 microns. The encapsulated fill material shall be separated from the interior perforated baffles by means of a non-combustible, erosion resistant, factory installed, acoustic stand-off. It shall not be acceptable to omit the acoustic stand-off and try to compensate for its absence by means of corrugated baffles. Combustion ratings for the acoustic fill, encapsulation film, and the acoustic stand-off shall be not greater than the following when tested in accordance with ASTM E48, NFPA standard 255 or U.L. No 723: Flamespread Classification – 20, Smoke Development Rating – 20.

### Applications include:

- Education
- Healthcare
- Recovery rooms
- Clean rooms
- Airborne pollution research
- Test rooms

### Construction

Silencer modules shall conform to HVAC DW 144 recommendations for high pressure duct-work. Seams shall be lock formed and mastic filled. Rectangular casing seams shall be in the corners of the silencer shell to provide maximum unit strength and rigidity. Interior partitions shall be fabricated from single piece; margin perforated sheets and shall have die-formed entrance and exit noses so as to provide the maximum aerodynamic efficiency and minimum self-noise characteristics in the silencer. Blunt noses or squared off partitions will not be accepted. Attachment of the interior partitions to the casing shall be by means of an interlocking track assembly. Rivets or self-tapping screws shall not be used to secure acoustic elements inside the silencer casing. Interior partitions shall be additionally secured to the outer casing with welded nose clips at both ends of the silencer.



Silencers shall not fail structurally when subjected to a differential air pressure of 2000Pa from inside to outside the casing. Airtight construction shall be provided by use of a duct sealing compound on the job site, material and labour furnished by the contractor.

### Acoustic Performance

Silencer ratings shall be determined in a duct-to-reverberant room test facility which provides for airflow in both directions through the test silencer in accordance with applicable sections of ASTM E 477 and ISO 7235. The test set-up and procedure shall be such that all effects due to the end reflection, directivity, flanking transmission, standing waves and test chamber sound absorption are eliminated. Acoustic ratings shall include Dynamic Insertion Loss (DIL) and Self-Noise (SN) Power Levels both for forward and reverse flow with airflow of at least 10m/s entering face velocity. Data for rectangular type silencers shall be presented for tests conducted using silencers no smaller than the following cross-sections in mm: 600 x 600, 600 x 750, or 600 x 900.

### Aerodynamic Performance

Static pressure loss of silencers shall not exceed those listed in the silencer schedule as the airflow indicates. Airflow measurements shall be made in accordance with ASTM specification E477 and applicable portions ASME, AMCA and ADC airflow test codes. Tests shall be reported on the identical units for which acoustic data is presented.

### Certification

With submittals, the manufacturer shall supply certified test data on Dynamic Insertion Loss, Self-Noise Power Levels, and Aerodynamic Performance for reverse and forward flow test conditions. Test data shall be for a standard product. All rating tests shall be conducted in the same facility, shall utilise the same silencer, and shall be open to inspection upon request from the Architect/Engineer.

### Duct Transitions

When transitions are required to adapt silencer dimensions to connecting duct-work, they shall be furnished by the installing contractor.

### Flanges

Provide flanges as detailed in the silencer schedules if required.

# Clean-Flow™ Quiet-Duct® Silencer Type: HLFS

Low Frequency with Forward and Reverse Flow Ratings

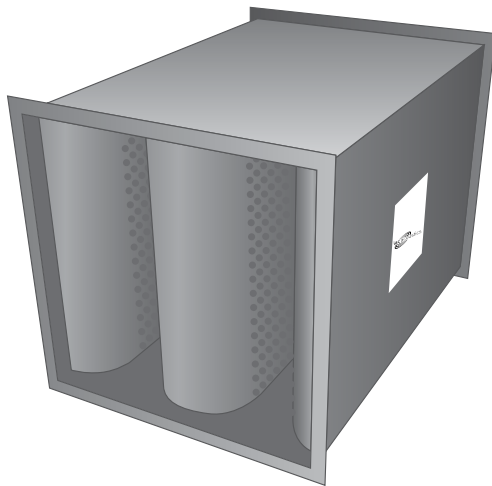

HLFS silencers are advantageous where low frequency DIL requirements are high in HVAC systems. The acoustic fill is totally encapsulated to prevent erosion or entrainment of particulate. A honeycomb acoustic stand-off provides additional protection and performance. Ideal for hospitals, laboratories and clean rooms.

## Supplied as Standard

- Aerodynamic inlet and discharge to splitter elements to reduce pressure drop and conserve energy
- Perforated galvanised steel facings to all splitter elements to protect acoustic media from damage and erosion

## Designating Silencers: Example

Model: 5HLFS-600-450

| Length | Type | Width | Height |
|--------|------|-------|--------|
| 1500mm | HLFS | 600mm | 450mm  |

## Self-Noise Power Levels dB re: 10<sup>-12</sup> Watts

| IAC HLFS Model              | Octave Band | 1  | 2   | 3   | 4   | 5  | 6  | 7  | 8  |
|-----------------------------|-------------|----|-----|-----|-----|----|----|----|----|
|                             | Hz          | 63 | 125 | 250 | 500 | 1K | 2K | 4K | 8K |
| Silencer Face Velocity, m/s |             |    |     |     |     |    |    |    |    |
| HLFS All Lengths (mm)       | -10         | 58 | 54  | 58  | 61  | 62 | 62 | 65 | 63 |
|                             | -7.5        | 51 | 49  | 53  | 56  | 56 | 59 | 60 | 53 |
|                             | -5          | 45 | 42  | 45  | 43  | 45 | 49 | 44 | 37 |
|                             | +5          | 46 | 42  | 45  | 43  | 45 | 49 | 44 | 37 |
|                             | +7.5        | 56 | 54  | 57  | 56  | 52 | 56 | 57 | 51 |
|                             | +10         | 68 | 64  | 65  | 66  | 61 | 61 | 64 | 61 |

## Aerodynamic Performance

| IAC Model                   | Length (mm) | Static Pressure Drop N/m <sup>2</sup> |      |      |      |      |      |      |      |
|-----------------------------|-------------|---------------------------------------|------|------|------|------|------|------|------|
|                             |             | 10                                    | 12   | 17   | 22   | 27   | 35   | 42   | 50   |
| HLFS                        | 900         | 10                                    | 12   | 17   | 22   | 27   | 35   | 42   | 50   |
|                             | 1500        | 10                                    | 15   | 20   | 25   | 32   | 40   | 47   | 55   |
|                             | 2100        | 10                                    | 15   | 20   | 25   | 32   | 40   | 50   | 57   |
|                             | 3000        | 10                                    | 15   | 22   | 27   | 35   | 45   | 52   | 65   |
| Silencer Face Velocity, m/s |             | 1.27                                  | 1.52 | 1.78 | 2.03 | 2.29 | 2.54 | 2.79 | 3.05 |

## Face Area Adjustment Factors (add or subtract from Lw values above)

|   |      |      |      |      |      |     |     |     |      |
|---|------|------|------|------|------|-----|-----|-----|------|
| Quiet-Duct® Face Area, m <sup>2</sup> * | 0.03 | 0.09 | 0.19 | 0.37 | 0.74 | 1.5 | 3.0 | 6.0 | 12.0 |
| Lw Adjustment Factor, dB                | -9   | -6   | -3   | 0    | +3   | +6  | +9  | +12 | +15  |

\* For intermediate face areas, interpolate to the nearest whole number

## Dynamic Insertion Loss (DIL) Ratings: Forward (+) / Reverse (-) Flow

| IAC HLFS Model (length in mm) | Octave Band                 | 1  | 2   | 3   | 4   | 5  | 6  | 7  | 8  |
|-------------------------------|-----------------------------|----|-----|-----|-----|----|----|----|----|
|                               | Hz                          | 63 | 125 | 250 | 500 | 1K | 2K | 4K | 8K |
|                               | Silencer Face Velocity, m/s |    |     |     |     |    |    |    |    |
| <b>3HLFS (900)</b>            | -10                         | 7  | 13  | 15  | 20  | 19 | 18 | 16 | 10 |
|                               | -5                          | 7  | 12  | 14  | 20  | 19 | 18 | 15 | 10 |
|                               | 0                           | 9  | 14  | 15  | 21  | 19 | 18 | 15 | 11 |
|                               | +5                          | 7  | 11  | 14  | 20  | 18 | 15 | 15 | 10 |
|                               | +10                         | 7  | 11  | 14  | 18  | 17 | 16 | 14 | 9  |
| <b>4HLFS (1200)</b>           | -10                         | 9  | 16  | 19  | 23  | 22 | 20 | 18 | 12 |
|                               | -5                          | 9  | 14  | 19  | 23  | 22 | 20 | 17 | 12 |
|                               | 0                           | 11 | 15  | 19  | 24  | 22 | 20 | 17 | 13 |
|                               | +5                          | 10 | 14  | 19  | 23  | 22 | 18 | 17 | 12 |
|                               | +10                         | 10 | 13  | 18  | 22  | 21 | 18 | 16 | 11 |
| <b>5HLFS (1500)</b>           | -10                         | 11 | 18  | 22  | 26  | 25 | 21 | 19 | 13 |
|                               | -5                          | 11 | 16  | 23  | 26  | 25 | 21 | 19 | 14 |
|                               | 0                           | 12 | 16  | 23  | 27  | 25 | 21 | 19 | 14 |
|                               | +5                          | 12 | 16  | 23  | 26  | 25 | 20 | 18 | 14 |
|                               | +10                         | 13 | 15  | 22  | 25  | 24 | 20 | 17 | 13 |
| <b>6HLFS (1800)</b>           | -10                         | 13 | 18  | 23  | 28  | 28 | 25 | 21 | 15 |
|                               | -5                          | 13 | 17  | 23  | 28  | 28 | 25 | 21 | 15 |
|                               | 0                           | 14 | 17  | 23  | 28  | 27 | 24 | 20 | 15 |
|                               | +5                          | 14 | 17  | 23  | 26  | 26 | 22 | 18 | 14 |
|                               | +10                         | 14 | 18  | 23  | 26  | 25 | 22 | 17 | 13 |
| <b>7HLFS (2100)</b>           | -10                         | 14 | 17  | 23  | 29  | 31 | 29 | 22 | 16 |
|                               | -5                          | 15 | 17  | 23  | 30  | 31 | 29 | 22 | 16 |
|                               | 0                           | 15 | 18  | 23  | 28  | 29 | 27 | 20 | 15 |
|                               | +5                          | 15 | 18  | 22  | 25  | 27 | 24 | 18 | 14 |
|                               | +10                         | 15 | 20  | 23  | 26  | 26 | 23 | 17 | 13 |
| <b>8HLFS (2400)</b>           | -10                         | 15 | 19  | 25  | 31  | 33 | 32 | 24 | 17 |
|                               | -5                          | 15 | 19  | 25  | 32  | 34 | 31 | 24 | 17 |
|                               | 0                           | 15 | 20  | 25  | 30  | 32 | 30 | 22 | 16 |
|                               | +5                          | 15 | 20  | 25  | 28  | 31 | 28 | 21 | 15 |
|                               | +10                         | 16 | 21  | 25  | 29  | 30 | 28 | 21 | 15 |
| <b>9HLFS (2700)</b>           | -10                         | 16 | 22  | 27  | 33  | 36 | 34 | 26 | 18 |
|                               | -5                          | 15 | 21  | 28  | 34  | 36 | 34 | 26 | 17 |
|                               | 0                           | 15 | 21  | 28  | 32  | 35 | 34 | 25 | 18 |
|                               | +5                          | 15 | 21  | 27  | 31  | 34 | 33 | 24 | 17 |
|                               | +10                         | 16 | 21  | 26  | 31  | 33 | 32 | 24 | 16 |
| <b>10HLFS (3000)</b>          | -10                         | 17 | 24  | 29  | 35  | 38 | 37 | 28 | 19 |
|                               | -5                          | 15 | 23  | 30  | 36  | 39 | 36 | 28 | 18 |
|                               | 0                           | 15 | 23  | 30  | 34  | 38 | 37 | 27 | 19 |
|                               | +5                          | 15 | 23  | 30  | 34  | 38 | 37 | 27 | 18 |
|                               | +10                         | 17 | 22  | 28  | 34  | 37 | 37 | 28 | 18 |

### Note

- Silencer Face Area is the cross-sectional area at the silencer entrance
- Face Velocity is the airflow (m<sup>3</sup>/s) divided by the Face Area (m<sup>2</sup>)
- Pressure drop for any face velocity can be calculated from the equation:  
 $PD = (\text{Actual FV} / \text{catalogue FV})^2 \times (\text{Catalogue PD})$
- Self Noise values shown are for a 0.37m<sup>2</sup> face area silencer
- For each doubling of face area add 3dB to the self noise values listed
- For each halving of face area subtract 3dB from the self noise values listed

# Clean-Flow™ Quiet-Duct® Silencer Type: HLFM

Low Frequency with Forward and Reverse Flow Ratings

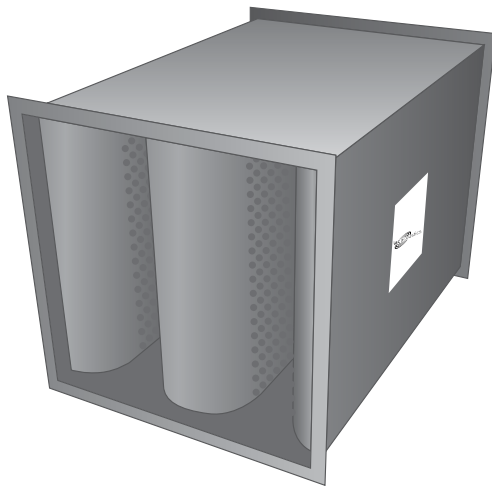

HLFM silencers provide improved low frequency attenuation for medium velocity HVAC systems. The acoustic fill is totally encapsulated to prevent erosion or entrainment of particulate. A honeycomb acoustic stand-off provides additional protection and performance.

### Supplied as Standard

- Aerodynamic inlet and discharge to splitter elements to reduce pressure drop and conserve energy
- Perforated galvanised steel facings to all splitter elements to protect acoustic media from damage and erosion

### Designating Silencers: Example

Model: 5HLFM-600-450

| Length | Type | Width | Height |
|--------|------|-------|--------|
| 1500mm | HLFM | 600mm | 450mm  |

### Self-Noise Power Levels dB re: 10<sup>-12</sup> Watts

| IAC HLFM Model              | Octave Band | 1  | 2   | 3   | 4   | 5  | 6  | 7  | 8  |
|-----------------------------|-------------|----|-----|-----|-----|----|----|----|----|
|                             | Hz          | 63 | 125 | 250 | 500 | 1K | 2K | 4K | 8K |
| Silencer Face Velocity, m/s |             |    |     |     |     |    |    |    |    |
| HLFM All Lengths (mm)       | -10         | 58 | 54  | 58  | 61  | 62 | 62 | 65 | 63 |
|                             | -7.5        | 51 | 49  | 53  | 56  | 56 | 59 | 60 | 53 |
|                             | -5          | 45 | 42  | 45  | 43  | 45 | 49 | 44 | 37 |
|                             | +5          | 46 | 42  | 45  | 43  | 45 | 49 | 44 | 37 |
|                             | +7.5        | 56 | 54  | 57  | 56  | 52 | 56 | 57 | 51 |
|                             | +10         | 68 | 64  | 65  | 66  | 61 | 61 | 64 | 61 |

### Aerodynamic Performance

| IAC Model                   | Length (mm) | Static Pressure Drop N/m <sup>2</sup> |      |      |      |      |      |      |      |
|-----------------------------|-------------|---------------------------------------|------|------|------|------|------|------|------|
| HLFM                        | 900         | 10                                    | 12   | 17   | 22   | 27   | 35   | 42   | 50   |
|                             | 1500        | 10                                    | 15   | 20   | 25   | 32   | 40   | 47   | 55   |
|                             | 2100        | 10                                    | 15   | 20   | 25   | 32   | 40   | 50   | 57   |
|                             | 3000        | 10                                    | 15   | 22   | 27   | 35   | 45   | 52   | 65   |
| Silencer Face Velocity, m/s |             | 1.27                                  | 1.52 | 1.78 | 2.03 | 2.29 | 2.54 | 2.79 | 3.05 |

### Face Area Adjustment Factors (add or subtract from Lw values above)

|   |      |      |      |      |      |     |     |     |      |
|---|------|------|------|------|------|-----|-----|-----|------|
| Quiet-Duct® Face Area, m <sup>2</sup> * | 0.03 | 0.09 | 0.19 | 0.37 | 0.74 | 1.5 | 3.0 | 6.0 | 12.0 |
| Lw Adjustment Factor, dB                | -9   | -6   | -3   | 0    | +3   | +6  | +9  | +12 | +15  |

\* For intermediate face areas, interpolate to the nearest whole number

## Dynamic Insertion Loss (DIL) Ratings: Forward (+) / Reverse (-) Flow

| IAC HLFM Model<br>(length in mm) | Octave Band                 | 1  | 2   | 3   | 4   | 5  | 6  | 7  | 8  |
|----------------------------------|-----------------------------|----|-----|-----|-----|----|----|----|----|
|                                  | Hz                          | 63 | 125 | 250 | 500 | 1K | 2K | 4K | 8K |
|                                  | Silencer Face Velocity, m/s |    |     |     |     |    |    |    |    |
| <b>3HLFM (900)</b>               | -10                         | 7  | 13  | 15  | 20  | 19 | 18 | 16 | 10 |
|                                  | -5                          | 7  | 12  | 14  | 20  | 19 | 18 | 15 | 10 |
|                                  | 0                           | 9  | 14  | 15  | 21  | 19 | 18 | 15 | 11 |
|                                  | +5                          | 7  | 11  | 14  | 20  | 18 | 15 | 15 | 10 |
|                                  | +10                         | 7  | 11  | 14  | 18  | 17 | 16 | 14 | 9  |
| <b>4HLFM (1200)</b>              | -10                         | 9  | 16  | 19  | 23  | 22 | 20 | 18 | 12 |
|                                  | -5                          | 9  | 14  | 19  | 23  | 22 | 20 | 17 | 12 |
|                                  | 0                           | 11 | 15  | 19  | 24  | 22 | 20 | 17 | 13 |
|                                  | +5                          | 10 | 14  | 19  | 23  | 22 | 18 | 17 | 12 |
|                                  | +10                         | 10 | 13  | 18  | 22  | 21 | 18 | 16 | 11 |
| <b>5HLFM (1500)</b>              | -10                         | 11 | 18  | 22  | 26  | 25 | 21 | 19 | 13 |
|                                  | -5                          | 11 | 16  | 23  | 26  | 25 | 21 | 19 | 14 |
|                                  | 0                           | 12 | 16  | 23  | 27  | 25 | 21 | 19 | 14 |
|                                  | +5                          | 12 | 16  | 23  | 26  | 25 | 20 | 18 | 14 |
|                                  | +10                         | 13 | 15  | 22  | 25  | 24 | 20 | 17 | 13 |
| <b>6HLFM (1800)</b>              | -10                         | 13 | 18  | 23  | 28  | 28 | 25 | 21 | 15 |
|                                  | -5                          | 13 | 17  | 23  | 28  | 28 | 25 | 21 | 15 |
|                                  | 0                           | 14 | 17  | 23  | 28  | 27 | 24 | 20 | 15 |
|                                  | +5                          | 14 | 17  | 23  | 26  | 26 | 22 | 18 | 14 |
|                                  | +10                         | 14 | 18  | 23  | 26  | 25 | 22 | 17 | 13 |
| <b>7HLFM (2100)</b>              | -10                         | 14 | 17  | 23  | 29  | 31 | 29 | 22 | 16 |
|                                  | -5                          | 15 | 17  | 23  | 30  | 31 | 29 | 22 | 16 |
|                                  | 0                           | 15 | 18  | 23  | 28  | 29 | 27 | 20 | 15 |
|                                  | +5                          | 15 | 18  | 22  | 25  | 27 | 24 | 18 | 14 |
|                                  | +10                         | 15 | 20  | 23  | 26  | 26 | 23 | 17 | 13 |
| <b>8HLFM (2400)</b>              | -10                         | 15 | 19  | 25  | 31  | 33 | 32 | 24 | 17 |
|                                  | -5                          | 15 | 19  | 25  | 32  | 34 | 31 | 24 | 17 |
|                                  | 0                           | 15 | 20  | 25  | 30  | 32 | 30 | 22 | 16 |
|                                  | +5                          | 15 | 20  | 25  | 28  | 31 | 28 | 21 | 15 |
|                                  | +10                         | 16 | 21  | 25  | 29  | 30 | 28 | 21 | 15 |
| <b>9HLFM (2700)</b>              | -10                         | 16 | 22  | 27  | 33  | 36 | 34 | 26 | 18 |
|                                  | -5                          | 15 | 21  | 28  | 34  | 36 | 34 | 26 | 17 |
|                                  | 0                           | 15 | 21  | 28  | 32  | 35 | 34 | 25 | 18 |
|                                  | +5                          | 15 | 21  | 27  | 31  | 34 | 33 | 24 | 17 |
|                                  | +10                         | 16 | 21  | 26  | 31  | 33 | 32 | 24 | 16 |
| <b>10HLFM (3000)</b>             | -10                         | 17 | 24  | 29  | 35  | 38 | 37 | 28 | 19 |
|                                  | -5                          | 15 | 23  | 30  | 36  | 39 | 36 | 28 | 18 |
|                                  | 0                           | 15 | 23  | 30  | 34  | 38 | 37 | 27 | 19 |
|                                  | +5                          | 15 | 23  | 30  | 34  | 38 | 37 | 27 | 18 |
|                                  | +10                         | 17 | 22  | 28  | 34  | 37 | 37 | 28 | 18 |

### Note

- Silencer Face Area is the cross-sectional area at the silencer entrance
- Face Velocity is the airflow (m<sup>3</sup>/s) divided by the Face Area (m<sup>2</sup>)
- Pressure drop for any face velocity can be calculated from the equation:  
 $PD = (\text{Actual FV} / \text{catalogue FV})^2 \times (\text{Catalogue PD})$
- Self Noise values shown are for a 0.37m<sup>2</sup> face area silencer
- For each doubling of face area add 3dB to the self noise values listed
- For each halving of face area subtract 3dB from the self noise values listed

# Clean-Flow™ Quiet-Duct® Silencer Type: HS

With Forward and Reverse Flow

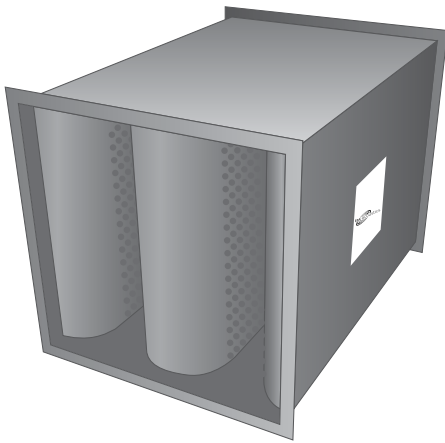

HS silencers are designed for air handling systems that require the ultimate in cleanliness and hygiene. They are **non-erosive** – to eliminate carry-over of inorganic particulate matter from the silencer. **Non-pregnant** – to prevent or minimise the absorption of gases and / or entry of Brownian particles into the fill. **Cleanable** – non-removable fill permits periodic cleaning of exposed surfaces with soft brush vacuum cleaner, optional removable parts also permit cleaning of concealed surfaces and replacement of acoustic fill.

## Supplied as Standard

- Aerodynamic inlet and discharge to splitter elements to reduce pressure drop and conserve energy
- Perforated galvanised steel facings to all splitter elements to protect acoustic media from damage and erosion

## Designating Silencers: Example

Model: 5HS-600-450

| Length | Type | Width | Height |
|--------|------|-------|--------|
| 1500mm | HS   | 600mm | 450mm  |

## Self-Noise Power Levels dB re: 10<sup>-12</sup> Watts

| IAC HS Model        | Octave Band                 | 1  | 2   | 3   | 4   | 5  | 6  | 7  | 8  |
|---------------------|-----------------------------|----|-----|-----|-----|----|----|----|----|
|                     | Hz                          | 63 | 125 | 250 | 500 | 1K | 2K | 4K | 8K |
|                     | Silencer Face Velocity, m/s |    |     |     |     |    |    |    |    |
| HS All Lengths (mm) | -10                         | 68 | 62  | 61  | 66  | 61 | 64 | 67 | 66 |
|                     | -5                          | 54 | 51  | 50  | 51  | 54 | 56 | 52 | 40 |
|                     | -2.5                        | 40 | 40  | 39  | 36  | 47 | 48 | 37 | 20 |
|                     | +2.5                        | 36 | 29  | 35  | 30  | 31 | 35 | 22 | 20 |
|                     | +5                          | 55 | 49  | 49  | 47  | 46 | 49 | 42 | 32 |
|                     | +10                         | 74 | 69  | 63  | 64  | 61 | 63 | 62 | 56 |

## Aerodynamic Performance

| IAC Model                   | Length (mm) | Static Pressure Drop N/m <sup>2</sup> |      |      |      |      |      |      |      |
|-----------------------------|-------------|---------------------------------------|------|------|------|------|------|------|------|
|                             |             | 2                                     | 7    | 13   | 22   | 32   | 45   | 57   | 72   |
| HS                          | 900         | 2                                     | 7    | 13   | 22   | 32   | 45   | 57   | 72   |
|                             | 1500        | 5                                     | 10   | 17   | 25   | 37   | 50   | 65   | 82   |
|                             | 2100        | 5                                     | 10   | 17   | 27   | 40   | 52   | 70   | 87   |
|                             | 3000        | 5                                     | 10   | 20   | 30   | 45   | 60   | 80   | 100  |
| Silencer Face Velocity, m/s |             | 1.02                                  | 1.52 | 2.03 | 2.54 | 3.05 | 3.56 | 4.06 | 4.57 |

## Face Area Adjustment Factors (add or subtract from Lw values above)

|   |      |      |      |      |      |     |     |     |      |
|---|------|------|------|------|------|-----|-----|-----|------|
| Quiet-Duct® Face Area, m <sup>2</sup> * | 0.05 | 0.09 | 0.19 | 0.37 | 0.74 | 1.5 | 3.0 | 6.0 | 12.0 |
| Lw Adjustment Factor, dB                | -9   | -6   | -3   | 0    | +3   | +6  | +9  | +12 | +15  |

\* For intermediate face areas, interpolate to the nearest whole number

## Dynamic Insertion Loss (DIL) Ratings: Forward (+) / Reverse (-) Flow

| IAC HS Model (length in mm) | Octave Band                 | 1  | 2   | 3   | 4   | 5  | 6  | 7  | 8  |
|-----------------------------|-----------------------------|----|-----|-----|-----|----|----|----|----|
|                             | Hz                          | 63 | 125 | 250 | 500 | 1K | 2K | 4K | 8K |
|                             | Silencer Face Velocity, m/s |    |     |     |     |    |    |    |    |
| <b>3HS (900)</b>            | -10                         | 7  | 12  | 15  | 22  | 26 | 30 | 28 | 14 |
|                             | -5                          | 5  | 9   | 17  | 25  | 27 | 32 | 29 | 14 |
|                             | 0                           | 5  | 7   | 15  | 33  | 26 | 30 | 19 | 14 |
|                             | +5                          | 5  | 6   | 13  | 21  | 24 | 28 | 29 | 13 |
|                             | +10                         | 5  | 8   | 11  | 17  | 21 | 26 | 31 | 13 |
| <b>4HS (1200)</b>           | -10                         | 11 | 14  | 19  | 25  | 31 | 36 | 31 | 15 |
|                             | -5                          | 7  | 11  | 20  | 28  | 34 | 40 | 32 | 15 |
|                             | 0                           | 7  | 9   | 19  | 31  | 32 | 38 | 27 | 15 |
|                             | +5                          | 7  | 9   | 16  | 25  | 30 | 36 | 21 | 14 |
|                             | +10                         | 7  | 10  | 14  | 20  | 27 | 33 | 32 | 14 |
| <b>5HS (1500)</b>           | -10                         | 14 | 15  | 22  | 27  | 35 | 42 | 33 | 15 |
|                             | -5                          | 9  | 13  | 23  | 31  | 40 | 47 | 34 | 16 |
|                             | 0                           | 8  | 11  | 22  | 29  | 38 | 46 | 34 | 16 |
|                             | +5                          | 8  | 12  | 18  | 28  | 36 | 44 | 34 | 14 |
|                             | +10                         | 8  | 12  | 16  | 23  | 32 | 40 | 33 | 15 |
| <b>6HS (1800)</b>           | -10                         | 15 | 17  | 23  | 29  | 40 | 46 | 34 | 14 |
|                             | -5                          | 12 | 15  | 24  | 36  | 44 | 49 | 35 | 15 |
|                             | 0                           | 11 | 13  | 22  | 34  | 43 | 48 | 36 | 16 |
|                             | +5                          | 10 | 12  | 19  | 33  | 43 | 47 | 36 | 16 |
|                             | +10                         | 10 | 12  | 16  | 27  | 39 | 45 | 34 | 16 |
| <b>7HS (2100)</b>           | -10                         | 15 | 18  | 23  | 31  | 45 | 49 | 34 | 13 |
|                             | -5                          | 15 | 17  | 25  | 41  | 48 | 50 | 36 | 14 |
|                             | 0                           | 13 | 15  | 22  | 39  | 48 | 50 | 38 | 15 |
|                             | +5                          | 11 | 12  | 19  | 38  | 49 | 50 | 38 | 17 |
|                             | +10                         | 11 | 11  | 16  | 31  | 45 | 50 | 35 | 16 |
| <b>8HS (2400)</b>           | -10                         | 17 | 19  | 25  | 32  | 46 | 49 | 34 | 12 |
|                             | -5                          | 17 | 19  | 28  | 42  | 50 | 50 | 36 | 13 |
|                             | 0                           | 14 | 17  | 25  | 40  | 49 | 50 | 38 | 15 |
|                             | +5                          | 12 | 13  | 22  | 39  | 50 | 50 | 38 | 18 |
|                             | +10                         | 12 | 13  | 19  | 32  | 46 | 50 | 35 | 16 |
| <b>9HS (2700)</b>           | -10                         | 18 | 21  | 28  | 33  | 48 | 50 | 33 | 12 |
|                             | -5                          | 18 | 22  | 30  | 43  | 50 | 51 | 36 | 12 |
|                             | 0                           | 16 | 18  | 28  | 41  | 55 | 51 | 38 | 15 |
|                             | +5                          | 13 | 15  | 24  | 39  | 50 | 50 | 39 | 18 |
|                             | +10                         | 13 | 15  | 21  | 33  | 47 | 50 | 36 | 16 |
| <b>10HS (3000)</b>          | -10                         | 20 | 22  | 30  | 34  | 49 | 50 | 33 | 11 |
|                             | -5                          | 20 | 24  | 33  | 44  | 51 | 51 | 36 | 11 |
|                             | 0                           | 17 | 20  | 31  | 42  | 52 | 51 | 38 | 15 |
|                             | +5                          | 14 | 16  | 27  | 40  | 51 | 50 | 39 | 19 |
|                             | +10                         | 17 | 22  | 28  | 34  | 37 | 37 | 28 | 18 |

### Note

- Silencer Face Area is the cross-sectional area at the silencer entrance
- Face Velocity is the airflow (m<sup>3</sup>/s) divided by the Face Area (m<sup>2</sup>)
- Pressure drop for any face velocity can be calculated from the equation:  
 $PD = (\text{Actual FV} / \text{catalogue FV})^2 \times (\text{Catalogue PD})$
- Self Noise values shown are for a 0.37m<sup>2</sup> face area silencer
- For each doubling of face area add 3dB to the self noise values listed
- For each halving of face area subtract 3dB from the self noise values listed

# Clean-Flow™ Quiet-Duct® Silencer Type: HMS

Low Frequency with Forward and Reverse Flow Ratings

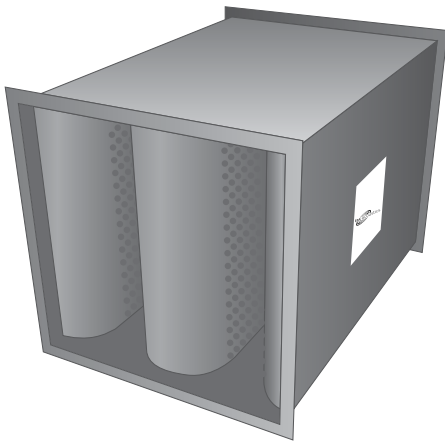

HMS silencers are designed for air handling systems that require the ultimate in cleanliness and hygiene. They are **non-erosive** – to eliminate carry-over of inorganic particulate matter from the silencer. **Non-pregnable** – to prevent or minimise the absorption of gases and / or entry of Brownian particles into the fill. **Cleanable** – non-removable fill permits periodic cleaning of exposed surfaces with soft brush vacuum cleaner, optional removable parts also permit cleaning of concealed surfaces and replacement of acoustic fill.

### Supplied as Standard

- Aerodynamic inlet and discharge to splitter elements to reduce pressure drop and conserve energy
- Perforated galvanised steel facings to all splitter elements to protect acoustic media from damage and erosion

### Designating Silencers: Example

Model: 5HMS-750-450

| Length | Type | Width | Height |
|--------|------|-------|--------|
| 1500mm | HMS  | 750mm | 450mm  |

### Self-Noise Power Levels dB re: 10<sup>-12</sup> Watts

| IAC HMS Model        | Octave Band                 | 1  | 2   | 3   | 4   | 5  | 6  | 7  | 8  |
|----------------------|-----------------------------|----|-----|-----|-----|----|----|----|----|
|                      | Hz                          | 63 | 125 | 250 | 500 | 1K | 2K | 4K | 8K |
|                      | Silencer Face Velocity, m/s |    |     |     |     |    |    |    |    |
| HMS All Lengths (mm) | -15                         | 67 | 63  | 61  | 66  | 61 | 64 | 67 | 67 |
|                      | -10                         | 60 | 56  | 56  | 53  | 57 | 59 | 58 | 49 |
|                      | -5                          | 46 | 45  | 45  | 41  | 50 | 51 | 43 | 23 |
|                      | +5                          | 44 | 32  | 36  | 34  | 31 | 32 | 29 | 21 |
|                      | +10                         | 63 | 54  | 52  | 50  | 47 | 48 | 47 | 44 |
|                      | +15                         | 74 | 64  | 60  | 58  | 56 | 58 | 59 | 57 |

### Aerodynamic Performance

| IAC Model                   | Length (mm) | Static Pressure Drop N/m <sup>2</sup> |      |      |      |      |      |      |      |
|-----------------------------|-------------|---------------------------------------|------|------|------|------|------|------|------|
|                             |             | 15                                    | 20   | 25   | 30   | 35   | 42   | 50   | 57   |
| HMS                         | 900         | 15                                    | 20   | 25   | 30   | 35   | 42   | 50   | 57   |
|                             | 1500        | 20                                    | 25   | 30   | 37   | 42   | 50   | 60   | 67   |
|                             | 2100        | 25                                    | 30   | 37   | 45   | 55   | 65   | 75   | 85   |
|                             | 3000        | 30                                    | 37   | 47   | 57   | 67   | 77   | 90   | 105  |
| Silencer Face Velocity, m/s |             | 4.06                                  | 4.57 | 5.08 | 5.59 | 6.10 | 6.60 | 7.11 | 7.62 |

### Face Area Adjustment Factors (add or subtract from Lw values above)

|   |      |      |      |      |      |      |      |      |      |
|---|------|------|------|------|------|------|------|------|------|
| Quiet-Duct® Face Area, m <sup>2</sup> * | 0.03 | 0.06 | 0.11 | 0.22 | 0.45 | 0.90 | 1.80 | 3.60 | 7.20 |
| Lw Adjustment Factor, dB                | -9   | -6   | -3   | 0    | +3   | +6   | +9   | +12  | +15  |

\* For intermediate face areas, interpolate to the nearest whole number



## Dynamic Insertion Loss (DIL) Ratings: Forward (+) / Reverse (-) Flow

| IAC HMS Model (length in mm) | Octave Band                 | 1  | 2   | 3   | 4   | 5  | 6  | 7  | 8  |
|------------------------------|-----------------------------|----|-----|-----|-----|----|----|----|----|
|                              | Hz                          | 63 | 125 | 250 | 500 | 1K | 2K | 4K | 8K |
|                              | Silencer Face Velocity, m/s |    |     |     |     |    |    |    |    |
| <b>3HMS (900)</b>            | -20                         | 4  | 6   | 10  | 15  | 18 | 22 | 16 | 8  |
|                              | -10                         | 5  | 6   | 9   | 15  | 17 | 21 | 17 | 8  |
|                              | 0                           | 5  | 6   | 9   | 15  | 17 | 18 | 17 | 8  |
|                              | +10                         | 4  | 4   | 8   | 14  | 17 | 17 | 16 | 8  |
|                              | +20                         | 4  | 3   | 7   | 13  | 16 | 18 | 17 | 8  |
| <b>4HMS (1200)</b>           | -20                         | 5  | 8   | 13  | 22  | 24 | 26 | 20 | 9  |
|                              | -10                         | 5  | 7   | 12  | 21  | 23 | 25 | 20 | 9  |
|                              | 0                           | 5  | 8   | 11  | 19  | 22 | 23 | 20 | 9  |
|                              | +10                         | 4  | 6   | 10  | 19  | 22 | 22 | 19 | 10 |
|                              | +20                         | 4  | 5   | 9   | 18  | 22 | 23 | 20 | 10 |
| <b>5HMS (1500)</b>           | -20                         | 6  | 10  | 15  | 29  | 29 | 30 | 23 | 9  |
|                              | -10                         | 4  | 8   | 14  | 27  | 29 | 29 | 23 | 9  |
|                              | 0                           | 4  | 9   | 13  | 25  | 29 | 28 | 23 | 10 |
|                              | +10                         | 3  | 7   | 11  | 24  | 27 | 27 | 22 | 12 |
|                              | +20                         | 3  | 6   | 10  | 22  | 28 | 28 | 22 | 12 |
| <b>6HMS (1800)</b>           | -20                         | 7  | 13  | 18  | 30  | 30 | 35 | 26 | 10 |
|                              | -10                         | 6  | 10  | 16  | 30  | 32 | 34 | 26 | 10 |
|                              | 0                           | 6  | 11  | 15  | 29  | 32 | 33 | 25 | 11 |
|                              | +10                         | 5  | 9   | 14  | 27  | 30 | 31 | 23 | 13 |
|                              | +20                         | 5  | 9   | 13  | 26  | 31 | 32 | 24 | 13 |
| <b>7HMS (2100)</b>           | -20                         | 8  | 15  | 21  | 31  | 30 | 39 | 28 | 11 |
|                              | -10                         | 7  | 12  | 18  | 33  | 35 | 38 | 28 | 11 |
|                              | 0                           | 7  | 13  | 17  | 32  | 34 | 37 | 26 | 12 |
|                              | +10                         | 7  | 11  | 16  | 30  | 33 | 34 | 24 | 13 |
|                              | +20                         | 6  | 11  | 15  | 29  | 34 | 35 | 26 | 14 |
| <b>8HMS (2400)</b>           | -20                         | 9  | 15  | 22  | 31  | 32 | 39 | 29 | 12 |
|                              | -10                         | 7  | 13  | 20  | 33  | 35 | 40 | 30 | 12 |
|                              | 0                           | 9  | 13  | 19  | 32  | 34 | 38 | 27 | 13 |
|                              | +10                         | 8  | 11  | 18  | 31  | 33 | 36 | 25 | 14 |
|                              | +20                         | 7  | 12  | 17  | 30  | 33 | 36 | 27 | 15 |
| <b>9HMS (2700)</b>           | -20                         | 10 | 14  | 24  | 30  | 34 | 40 | 31 | 14 |
|                              | -10                         | 10 | 13  | 22  | 32  | 36 | 41 | 31 | 13 |
|                              | 0                           | 10 | 14  | 21  | 33  | 35 | 40 | 29 | 14 |
|                              | +10                         | 9  | 12  | 21  | 31  | 34 | 38 | 27 | 15 |
|                              | +20                         | 8  | 12  | 19  | 30  | 33 | 36 | 29 | 17 |
| <b>10HMS (3000)</b>          | -20                         | 11 | 14  | 25  | 30  | 36 | 40 | 32 | 15 |
|                              | -10                         | 11 | 14  | 24  | 32  | 36 | 43 | 33 | 14 |
|                              | 0                           | 12 | 14  | 23  | 33  | 35 | 41 | 30 | 15 |
|                              | +10                         | 10 | 12  | 23  | 32  | 34 | 40 | 28 | 16 |
|                              | +20                         | 9  | 13  | 21  | 31  | 32 | 37 | 30 | 18 |

### Note

- Silencer Face Area is the cross-sectional area at the silencer entrance
- Face Velocity is the airflow (m<sup>3</sup>/s) divided by the Face Area (m<sup>2</sup>)
- Pressure drop for any face velocity can be calculated from the equation:  
 $PD = (\text{Actual FV} / \text{catalogue FV})^2 \times (\text{Catalogue PD})$
- Self Noise values shown are for a 0.22m<sup>2</sup> face area silencer
- For each doubling of face area add 3dB to the self noise values listed
- For each halving of face area subtract 3dB from the self noise values listed

# Clean-Flow™ Quiet-Duct® Silencer Type: HLFL

Low Frequency with Forward and Reverse Flow Ratings

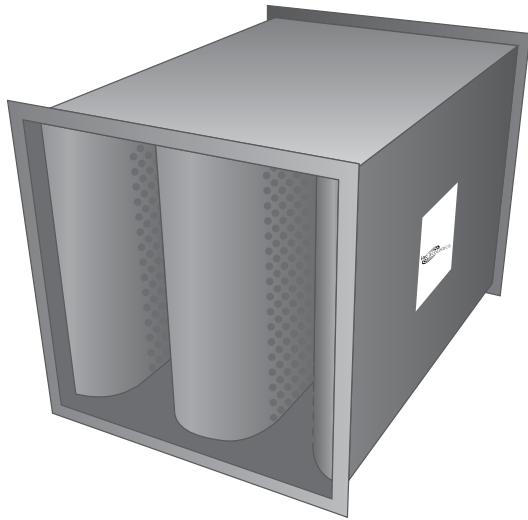

HLFL silencers provide improved low frequency attenuation with low pressure drop for higher velocity HVAC systems. The acoustic fill is totally encapsulated to prevent erosion or entrainment of particulate. A honeycomb acoustic stand-off provides additional protection and performance.

### Supplied as Standard

- Aerodynamic inlet and discharge to splitter elements to reduce pressure drop and conserve energy
- Perforated galvanised steel facings to all splitter elements to protect acoustic media from damage and erosion

### Designating Silencers: Example

Model: 5HLFL-600-450

| Length | Type | Width | Height |
|--------|------|-------|--------|
| 1500mm | HLFL | 600mm | 450mm  |

### Self-Noise Power Levels dB re: 10<sup>-12</sup> Watts

| IAC HLFL Model        | Octave Band                 | 1  | 2   | 3   | 4   | 5  | 6  | 7  | 8  |
|-----------------------|-----------------------------|----|-----|-----|-----|----|----|----|----|
|                       | Hz                          | 63 | 125 | 250 | 500 | 1K | 2K | 4K | 8K |
|                       | Silencer Face Velocity, m/s |    |     |     |     |    |    |    |    |
| HLFL All Lengths (mm) | -15                         | 64 | 59  | 59  | 63  | 60 | 62 | 63 | 59 |
|                       | -10                         | 56 | 53  | 52  | 53  | 56 | 58 | 52 | 44 |
|                       | -5                          | 42 | 42  | 41  | 38  | 49 | 50 | 37 | 20 |
|                       | +5                          | 39 | 35  | 30  | 27  | 26 | 28 | 28 | 20 |
|                       | +10                         | 58 | 52  | 46  | 43  | 42 | 45 | 45 | 39 |
|                       | +15                         | 71 | 61  | 55  | 53  | 51 | 55 | 56 | 52 |

### Aerodynamic Performance

| IAC Model                   | Length (mm) | Static Pressure Drop N/m <sup>2</sup> |      |      |      |      |       |       |       |
|-----------------------------|-------------|---------------------------------------|------|------|------|------|-------|-------|-------|
|                             |             | 5.08                                  | 6.10 | 7.11 | 8.13 | 9.14 | 10.16 | 11.18 | 12.19 |
| HLFL                        | 900         | 12                                    | 17   | 25   | 32   | 40   | 50    | 60    | 70    |
|                             | 1500        | 15                                    | 20   | 30   | 37   | 47   | 60    | 70    | 85    |
|                             | 2100        | 17                                    | 27   | 35   | 47   | 60   | 72    | 90    | 105   |
|                             | 3000        | 22                                    | 32   | 45   | 57   | 72   | 90    | 110   | 130   |
| Silencer Face Velocity, m/s |             | 5.08                                  | 6.10 | 7.11 | 8.13 | 9.14 | 10.16 | 11.18 | 12.19 |

### Face Area Adjustment Factors (add or subtract from Lw values above)

|   |      |      |      |      |      |     |     |     |      |
|---|------|------|------|------|------|-----|-----|-----|------|
| Quiet-Duct® Face Area, m <sup>2</sup> * | 0.05 | 0.09 | 0.19 | 0.37 | 0.74 | 1.5 | 3.0 | 6.0 | 12.0 |
| Lw Adjustment Factor, dB                | -9   | -6   | -3   | 0    | +3   | +6  | +9  | +12 | +15  |

\* For intermediate face areas, interpolate to the nearest whole number

## Dynamic Insertion Loss (DIL) Ratings: Forward (+) / Reverse (-) Flow

| IAC HLFL Model (length in mm) | Octave Band                 | 1  | 2   | 3   | 4   | 5  | 6  | 7  | 8  |
|-------------------------------|-----------------------------|----|-----|-----|-----|----|----|----|----|
|                               | Hz                          | 63 | 125 | 250 | 500 | 1K | 2K | 4K | 8K |
|                               | Silencer Face Velocity, m/s |    |     |     |     |    |    |    |    |
| <b>3HLFL (900)</b>            | -10                         | 4  | 6   | 10  | 13  | 16 | 11 | 11 | 6  |
|                               | -5                          | 3  | 6   | 9   | 13  | 16 | 11 | 10 | 7  |
|                               | 0                           | 3  | 6   | 10  | 16  | 16 | 13 | 10 | 7  |
|                               | +5                          | 3  | 6   | 10  | 17  | 18 | 15 | 10 | 7  |
|                               | +10                         | 3  | 6   | 9   | 16  | 18 | 12 | 10 | 5  |
| <b>4HLFL (1200)</b>           | -10                         | 5  | 7   | 13  | 17  | 20 | 14 | 13 | 8  |
|                               | -5                          | 5  | 8   | 12  | 17  | 20 | 14 | 12 | 9  |
|                               | 0                           | 5  | 7   | 12  | 18  | 19 | 14 | 12 | 8  |
|                               | +5                          | 4  | 7   | 12  | 18  | 20 | 15 | 11 | 8  |
|                               | +10                         | 4  | 7   | 12  | 17  | 20 | 14 | 11 | 7  |
| <b>5HLFL (1500)</b>           | -10                         | 6  | 8   | 15  | 20  | 23 | 16 | 14 | 10 |
|                               | -5                          | 7  | 9   | 15  | 20  | 23 | 17 | 13 | 10 |
|                               | 0                           | 6  | 8   | 14  | 20  | 22 | 15 | 13 | 9  |
|                               | +5                          | 5  | 7   | 14  | 19  | 22 | 14 | 12 | 8  |
|                               | +10                         | 4  | 7   | 14  | 17  | 21 | 15 | 12 | 8  |
| <b>6HLFL (1800)</b>           | -10                         | 7  | 10  | 17  | 23  | 25 | 21 | 15 | 11 |
|                               | -5                          | 7  | 11  | 16  | 23  | 25 | 21 | 15 | 11 |
|                               | 0                           | 6  | 10  | 15  | 23  | 24 | 20 | 15 | 10 |
|                               | +5                          | 6  | 9   | 15  | 22  | 24 | 19 | 15 | 10 |
|                               | +10                         | 5  | 9   | 15  | 20  | 23 | 21 | 14 | 10 |
| <b>7HLFL (2100)</b>           | -10                         | 7  | 12  | 18  | 25  | 27 | 25 | 16 | 11 |
|                               | -5                          | 6  | 12  | 17  | 26  | 27 | 25 | 17 | 12 |
|                               | 0                           | 6  | 12  | 16  | 26  | 26 | 24 | 16 | 11 |
|                               | +5                          | 6  | 10  | 16  | 25  | 25 | 24 | 18 | 11 |
|                               | +10                         | 6  | 10  | 15  | 23  | 24 | 26 | 16 | 11 |
| <b>8HLFL (2400)</b>           | -10                         | 8  | 13  | 20  | 28  | 30 | 25 | 17 | 11 |
|                               | -5                          | 7  | 13  | 19  | 29  | 30 | 25 | 17 | 12 |
|                               | 0                           | 7  | 13  | 18  | 28  | 29 | 25 | 16 | 11 |
|                               | +5                          | 7  | 11  | 18  | 28  | 28 | 25 | 18 | 11 |
|                               | +10                         | 7  | 11  | 17  | 26  | 27 | 26 | 16 | 11 |
| <b>9HLFL (2700)</b>           | -10                         | 9  | 14  | 22  | 30  | 33 | 25 | 18 | 12 |
|                               | -5                          | 7  | 14  | 22  | 32  | 33 | 26 | 18 | 12 |
|                               | 0                           | 7  | 13  | 21  | 31  | 31 | 25 | 17 | 12 |
|                               | +5                          | 7  | 12  | 20  | 30  | 30 | 25 | 17 | 12 |
|                               | +10                         | 7  | 11  | 19  | 29  | 30 | 26 | 16 | 12 |
| <b>10HLFL (3000)</b>          | -10                         | 10 | 15  | 24  | 33  | 36 | 25 | 19 | 12 |
|                               | -5                          | 8  | 15  | 24  | 35  | 36 | 26 | 18 | 12 |
|                               | 0                           | 8  | 14  | 23  | 33  | 34 | 26 | 17 | 12 |
|                               | +5                          | 8  | 13  | 22  | 33  | 33 | 26 | 17 | 12 |
|                               | +10                         | 8  | 12  | 21  | 32  | 33 | 26 | 16 | 12 |

Clean-Flow™ Rectangular HLFL Silencer

### Note

- Silencer Face Area is the cross-sectional area at the silencer entrance
- Face Velocity is the airflow (m<sup>3</sup>/s) divided by the Face Area (m<sup>2</sup>)
- Pressure drop for any face velocity can be calculated from the equation:  
 $PD = (\text{Actual FV} / \text{catalogue FV})^2 \times (\text{Catalogue PD})$
- Self Noise values shown are for a 0.37m<sup>2</sup> face area silencer
- For each doubling of face area add 3dB to the self noise values listed
- For each halving of face area subtract 3dB from the self noise values listed

# Clean-Flow™ Quiet-Duct® Silencer Type: HL

With Forward and Reverse Flow Ratings

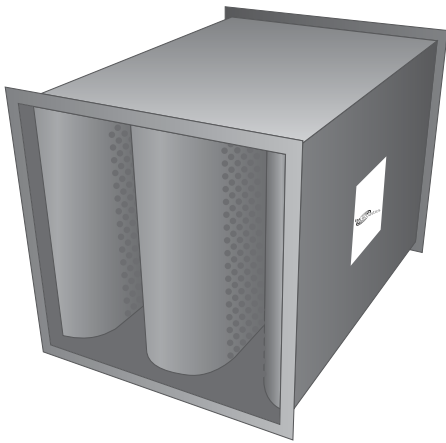

HL silencers are designed for air handling systems that require the ultimate in cleanliness and hygiene. They are **non-erosive** – to eliminate carry-over of inorganic particulate matter from the silencer. **Non-pregnable** – to prevent or minimise the absorption of gases and / or entry of Brownian particles into the fill. **Cleanable** – non-removable fill permits periodic cleaning of exposed surfaces with soft brush vacuum cleaner, optional removable parts also permit cleaning of concealed surfaces and replacement of acoustic fill.

### Supplied as Standard

- Aerodynamic inlet and discharge to splitter elements to reduce pressure drop and conserve energy
- Perforated galvanised steel facings to all splitter elements to protect acoustic media from damage and erosion

### Designating Silencers: Example

Model: 5HL-600-450

| Length | Type | Width | Height |
|--------|------|-------|--------|
| 1500mm | HL   | 600mm | 450mm  |

### Self-Noise Power Levels dB re: 10<sup>-12</sup> Watts

| IAC HL Model        | Octave Band                 | 1  | 2   | 3   | 4   | 5  | 6  | 7  | 8  |
|---------------------|-----------------------------|----|-----|-----|-----|----|----|----|----|
|                     | Hz                          | 63 | 125 | 250 | 500 | 1K | 2K | 4K | 8K |
|                     | Silencer Face Velocity, m/s |    |     |     |     |    |    |    |    |
| HL All Lengths (mm) | -15                         | 64 | 59  | 58  | 62  | 60 | 62 | 62 | 58 |
|                     | -10                         | 55 | 52  | 52  | 53  | 56 | 56 | 56 | 43 |
|                     | -5                          | 41 | 41  | 41  | 38  | 49 | 48 | 38 | 20 |
|                     | +5                          | 38 | 31  | 37  | 32  | 32 | 36 | 24 | 20 |
|                     | +10                         | 57 | 51  | 51  | 49  | 47 | 50 | 44 | 35 |
|                     | +15                         | 68 | 63  | 59  | 60  | 56 | 58 | 56 | 50 |

### Aerodynamic Performance

| IAC Model                   | Length (mm) | Static Pressure Drop N/m <sup>2</sup> |      |      |      |      |       |       |       |
|-----------------------------|-------------|---------------------------------------|------|------|------|------|-------|-------|-------|
|                             |             | 5.08                                  | 6.10 | 7.11 | 8.13 | 9.14 | 10.16 | 11.18 | 12.19 |
| HL                          | 900         | 12                                    | 17   | 32   | 37   | 37   | 50    | 60    | 72    |
|                             | 1500        | 15                                    | 20   | 27   | 35   | 45   | 55    | 67    | 80    |
|                             | 2100        | 15                                    | 22   | 30   | 37   | 47   | 60    | 72    | 87    |
|                             | 3000        | 17                                    | 25   | 32   | 42   | 55   | 67    | 82    | 97    |
| Silencer Face Velocity, m/s |             | 5.08                                  | 6.10 | 7.11 | 8.13 | 9.14 | 10.16 | 11.18 | 12.19 |

### Face Area Adjustment Factors (add or subtract from Lw values above)

|   |      |      |      |      |      |     |     |     |      |
|---|------|------|------|------|------|-----|-----|-----|------|
| Quiet-Duct® Face Area, m <sup>2</sup> * | 0.05 | 0.09 | 0.19 | 0.37 | 0.74 | 1.5 | 3.0 | 6.0 | 12.0 |
| Lw Adjustment Factor, dB                | -9   | -6   | -3   | 0    | +3   | +6  | +9  | +12 | +15  |

\* For intermediate face areas, interpolate to the nearest whole number

## Dynamic Insertion Loss (DIL) Ratings: Forward (+) / Reverse (-) Flow

| IAC HL Model (length in mm) | Octave Band                 | 1  | 2   | 3   | 4   | 5  | 6  | 7  | 8  |
|-----------------------------|-----------------------------|----|-----|-----|-----|----|----|----|----|
|                             | Hz                          | 63 | 125 | 250 | 500 | 1K | 2K | 4K | 8K |
|                             | Silencer Face Velocity, m/s |    |     |     |     |    |    |    |    |
| <b>3HL (900)</b>            | -25                         | 1  | 2   | 3   | 8   | 9  | 20 | 17 | 10 |
|                             | -10                         | 2  | 3   | 3   | 8   | 8  | 19 | 17 | 9  |
|                             | 0                           | 3  | 4   | 4   | 8   | 8  | 18 | 17 | 8  |
|                             | +10                         | 2  | 4   | 3   | 7   | 7  | 17 | 17 | 6  |
|                             | +25                         | 2  | 4   | 3   | 5   | 4  | 12 | 16 | 5  |
| <b>4HL (1200)</b>           | -25                         | 3  | 6   | 8   | 13  | 17 | 26 | 22 | 10 |
|                             | -10                         | 4  | 6   | 7   | 13  | 16 | 28 | 20 | 10 |
|                             | 0                           | 4  | 6   | 7   | 12  | 15 | 27 | 20 | 9  |
|                             | +10                         | 3  | 5   | 5   | 11  | 14 | 25 | 20 | 8  |
|                             | +25                         | 3  | 5   | 5   | 8   | 10 | 20 | 20 | 7  |
| <b>5HL (1500)</b>           | -25                         | 5  | 9   | 12  | 18  | 25 | 32 | 26 | 10 |
|                             | -10                         | 5  | 8   | 10  | 17  | 24 | 37 | 23 | 10 |
|                             | 0                           | 5  | 8   | 10  | 16  | 22 | 36 | 22 | 10 |
|                             | +10                         | 4  | 6   | 7   | 15  | 20 | 33 | 22 | 9  |
|                             | +25                         | 4  | 5   | 6   | 11  | 16 | 28 | 23 | 8  |
| <b>6HL (1800)</b>           | -25                         | 5  | 10  | 13  | 20  | 26 | 32 | 23 | 10 |
|                             | -10                         | 6  | 8   | 10  | 18  | 25 | 40 | 22 | 10 |
|                             | 0                           | 6  | 8   | 10  | 17  | 23 | 39 | 22 | 10 |
|                             | +10                         | 5  | 7   | 8   | 16  | 20 | 36 | 22 | 9  |
|                             | +25                         | 4  | 6   | 6   | 12  | 17 | 30 | 23 | 8  |
| <b>7HL (2100)</b>           | -25                         | 5  | 10  | 13  | 21  | 27 | 32 | 20 | 10 |
|                             | -10                         | 6  | 7   | 10  | 19  | 25 | 42 | 21 | 10 |
|                             | 0                           | 6  | 8   | 10  | 18  | 24 | 41 | 21 | 9  |
|                             | +10                         | 5  | 7   | 9   | 16  | 20 | 38 | 21 | 8  |
|                             | +25                         | 4  | 6   | 6   | 13  | 17 | 32 | 22 | 8  |
| <b>8HL (2400)</b>           | -25                         | 6  | 11  | 14  | 23  | 27 | 31 | 19 | 10 |
|                             | -10                         | 7  | 7   | 11  | 21  | 26 | 43 | 21 | 10 |
|                             | 0                           | 7  | 8   | 11  | 20  | 26 | 43 | 21 | 9  |
|                             | +10                         | 6  | 7   | 10  | 18  | 23 | 41 | 21 | 8  |
|                             | +25                         | 4  | 6   | 6   | 15  | 16 | 35 | 22 | 8  |
| <b>9HL (2700)</b>           | -25                         | 6  | 11  | 15  | 24  | 28 | 31 | 19 | 9  |
|                             | -10                         | 8  | 8   | 11  | 22  | 28 | 43 | 20 | 9  |
|                             | 0                           | 8  | 8   | 11  | 21  | 27 | 44 | 20 | 8  |
|                             | +10                         | 7  | 6   | 10  | 20  | 25 | 44 | 20 | 8  |
|                             | +25                         | 5  | 6   | 7   | 16  | 21 | 37 | 21 | 9  |
| <b>10HL (3000)</b>          | -25                         | 7  | 12  | 16  | 26  | 28 | 30 | 18 | 9  |
|                             | -10                         | 9  | 8   | 12  | 24  | 29 | 44 | 20 | 9  |
|                             | 0                           | 9  | 8   | 12  | 23  | 29 | 46 | 20 | 9  |
|                             | +10                         | 8  | 6   | 11  | 22  | 28 | 47 | 20 | 8  |
|                             | +25                         | 5  | 6   | 7   | 18  | 23 | 40 | 21 | 9  |

### Note

- Silencer Face Area is the cross-sectional area at the silencer entrance
- Face Velocity is the airflow (m<sup>3</sup>/s) divided by the Face Area (m<sup>2</sup>)
- Pressure drop for any face velocity can be calculated from the equation:  
 $PD = (\text{Actual FV} / \text{catalogue FV})^2 \times (\text{Catalogue PD})$
- Self Noise values shown are for a 0.37m<sup>2</sup> face area silencer
- For each doubling of face area add 3dB to the self noise values listed
- For each halving of face area subtract 3dB from the self noise values listed

# Clean-Flow™ Quiet-Duct® Silencer Type: HML

Low Frequency with Forward and Reverse Flow Ratings

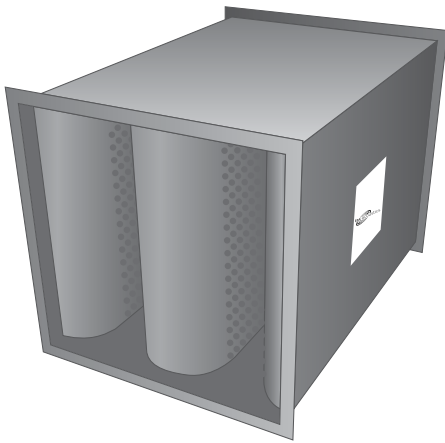

HML silencers are designed for air handling systems that require the ultimate in cleanliness and hygiene. They are **non-erosive** – to eliminate carry-over of inorganic particulate matter from the silencer. **Non-pregnable** – to prevent or minimise the absorption of gases and / or entry of Brownian particles into the fill. **Cleanable** – non-removable fill permits periodic cleaning of exposed surfaces with soft brush vacuum cleaner, optional removable parts also permit cleaning of concealed surfaces and replacement of acoustic fill.

### Supplied as Standard

- Aerodynamic inlet and discharge to splitter elements to reduce pressure drop and conserve energy
- Perforated galvanised steel facings to all splitter elements to protect acoustic media from damage and erosion

### Designating Silencers: Example

Model: 5HML-450-600

| Length | Type | Width | Height |
|--------|------|-------|--------|
| 1500mm | HML  | 450mm | 600mm  |

### Self-Noise Power Levels dB re: 10<sup>-12</sup> Watts

| IAC HML Model        | Octave Band                 | 1  | 2   | 3   | 4   | 5  | 6  | 7  | 8  |
|----------------------|-----------------------------|----|-----|-----|-----|----|----|----|----|
|                      | Hz                          | 63 | 125 | 250 | 500 | 1K | 2K | 4K | 8K |
|                      | Silencer Face Velocity, m/s |    |     |     |     |    |    |    |    |
| HML All Lengths (mm) | -15                         | 67 | 63  | 61  | 66  | 61 | 64 | 67 | 67 |
|                      | -10                         | 60 | 56  | 56  | 53  | 57 | 59 | 58 | 49 |
|                      | -5                          | 46 | 45  | 45  | 41  | 50 | 51 | 43 | 23 |
|                      | +5                          | 44 | 32  | 36  | 34  | 31 | 32 | 29 | 21 |
|                      | +10                         | 63 | 54  | 52  | 50  | 47 | 48 | 47 | 44 |
|                      | +15                         | 74 | 64  | 60  | 58  | 56 | 58 | 59 | 57 |

### Aerodynamic Performance

| IAC Model                   | Length (mm) | Static Pressure Drop N/m <sup>2</sup> |      |      |      |      |      |      |      |
|-----------------------------|-------------|---------------------------------------|------|------|------|------|------|------|------|
|                             |             | 15                                    | 20   | 25   | 30   | 35   | 42   | 50   | 57   |
| HML                         | 900         | 15                                    | 20   | 25   | 30   | 35   | 42   | 50   | 57   |
|                             | 1500        | 20                                    | 25   | 30   | 37   | 42   | 50   | 60   | 67   |
|                             | 2100        | 25                                    | 30   | 37   | 45   | 55   | 65   | 75   | 85   |
|                             | 3000        | 30                                    | 37   | 47   | 57   | 67   | 77   | 90   | 105  |
| Silencer Face Velocity, m/s |             | 4.06                                  | 4.57 | 5.08 | 5.59 | 6.10 | 6.60 | 7.11 | 7.62 |

### Face Area Adjustment Factors (add or subtract from Lw values above)

|   |      |      |      |      |      |      |      |      |      |
|---|------|------|------|------|------|------|------|------|------|
| Quiet-Duct® Face Area, m <sup>2</sup> * | 0.03 | 0.07 | 0.13 | 0.27 | 0.54 | 1.08 | 2.16 | 4.32 | 8.64 |
| Lw Adjustment Factor, dB                | -9   | -6   | -3   | 0    | +3   | +6   | +9   | +12  | +15  |

\* For intermediate face areas, interpolate to the nearest whole number

## Dynamic Insertion Loss (DIL) Ratings: Forward (+) / Reverse (-) Flow

| IAC HML Model (length in mm) | Octave Band                 | 1  | 2   | 3   | 4   | 5  | 6  | 7  | 8  |
|------------------------------|-----------------------------|----|-----|-----|-----|----|----|----|----|
|                              | Hz                          | 63 | 125 | 250 | 500 | 1K | 2K | 4K | 8K |
|                              | Silencer Face Velocity, m/s |    |     |     |     |    |    |    |    |
| <b>3HML (900)</b>            | -25                         | 4  | 4   | 7   | 14  | 12 | 7  | 8  | 4  |
|                              | -10                         | 3  | 4   | 7   | 13  | 12 | 8  | 8  | 4  |
|                              | 0                           | 3  | 4   | 7   | 13  | 12 | 7  | 9  | 5  |
|                              | +10                         | 3  | 2   | 6   | 12  | 11 | 8  | 9  | 6  |
|                              | +25                         | 2  | 3   | 6   | 11  | 11 | 8  | 10 |    |
| <b>4HML (1200)</b>           | -25                         | 5  | 6   | 10  | 20  | 19 | 9  | 8  | 5  |
|                              | -10                         | 4  | 5   | 10  | 18  | 18 | 10 | 8  | 5  |
|                              | 0                           | 4  | 5   | 9   | 18  | 18 | 10 | 10 | 6  |
|                              | +10                         | 3  | 4   | 8   | 17  | 17 | 12 | 11 | 8  |
|                              | +25                         | 3  | 5   | 8   | 16  | 18 | 11 | 11 |    |
| <b>5HML (1500)</b>           | -25                         | 5  | 7   | 12  | 25  | 25 | 11 | 7  | 5  |
|                              | -10                         | 4  | 6   | 12  | 23  | 24 | 11 | 8  | 5  |
|                              | 0                           | 4  | 6   | 11  | 23  | 24 | 13 | 10 | 7  |
|                              | +10                         | 3  | 5   | 10  | 22  | 23 | 15 | 12 | 9  |
|                              | +25                         | 3  | 6   | 10  | 20  | 24 | 14 | 12 | 9  |
| <b>6HML (1800)</b>           | -25                         | 5  | 8   | 14  | 28  | 28 | 15 | 12 | 8  |
|                              | -10                         | 5  | 7   | 14  | 26  | 28 | 14 | 12 | 7  |
|                              | 0                           | 5  | 8   | 13  | 25  | 28 | 16 | 13 | 9  |
|                              | +10                         | 4  | 6   | 11  | 23  | 27 | 18 | 14 | 10 |
|                              | +25                         | 4  | 7   | 10  | 23  | 27 | 18 | 14 | 10 |
| <b>7HML (2100)</b>           | -25                         | 5  | 9   | 16  | 30  | 30 | 18 | 16 | 10 |
|                              | -10                         | 6  | 8   | 15  | 29  | 31 | 17 | 15 | 9  |
|                              | 0                           | 6  | 9   | 14  | 27  | 31 | 18 | 16 | 10 |
|                              | +10                         | 5  | 7   | 12  | 24  | 31 | 21 | 16 | 11 |
|                              | +25                         | 5  | 7   | 10  | 25  | 29 | 21 | 16 | 11 |
| <b>8HML (2400)</b>           | -25                         | 6  | 11  | 17  | 31  | 31 | 20 | 16 | 11 |
|                              | -10                         | 7  | 9   | 16  | 34  | 33 | 19 | 15 | 10 |
|                              | 0                           | 7  | 10  | 15  | 28  | 33 | 20 | 16 | 11 |
|                              | +10                         | 6  | 8   | 14  | 26  | 32 | 23 | 16 | 11 |
|                              | +25                         | 6  | 8   | 12  | 27  | 31 | 23 | 16 | 12 |
| <b>9HML (2700)</b>           | -25                         | 8  | 11  | 19  | 31  | 33 | 22 | 15 | 11 |
|                              | -10                         | 7  | 11  | 18  | 32  | 35 | 21 | 16 | 11 |
|                              | 0                           | 8  | 11  | 17  | 30  | 34 | 23 | 16 | 11 |
|                              | +10                         | 6  | 10  | 15  | 29  | 34 | 24 | 17 | 12 |
|                              | +25                         | 7  | 9   | 15  | 30  | 34 | 24 | 17 | 13 |
| <b>10HML (3000)</b>          | -25                         | 9  | 12  | 20  | 32  | 34 | 24 | 15 | 12 |
|                              | -10                         | 8  | 12  | 19  | 33  | 37 | 23 | 16 | 12 |
|                              | 0                           | 9  | 12  | 18  | 31  | 36 | 25 | 16 | 12 |
|                              | +10                         | 7  | 11  | 17  | 31  | 35 | 26 | 17 | 12 |
|                              | +25                         | 8  | 10  | 17  | 32  | 36 | 26 | 17 | 14 |

### Note

- Silencer Face Area is the cross-sectional area at the silencer entrance
- Face Velocity is the airflow (m<sup>3</sup>/s) divided by the Face Area (m<sup>2</sup>)
- Pressure drop for any face velocity can be calculated from the equation:  
 $PD = (\text{Actual FV} / \text{catalogue FV})^2 \times (\text{Catalogue PD})$
- Self Noise values shown are for a 0.27m<sup>2</sup> face area silencer
- For each doubling of face area add 3dB to the self noise values listed
- For each halving of face area subtract 3dB from the self noise values listed

# Specifications:

## D-Duct Acoustic Diffuser Silencers

IAC designs D-Duct Diffuser Silencers (DDS) for installation at the outlet of vane axial fans. The combined interior diffuser cone and exterior square jacket casing make these units into aerodynamic regain devices as well as silencers. The DDS is an effective inlet cone and silencer.

### General

Furnish and install D-Duct Acoustic Diffuser style silencers of the types and sizes shown on plans and/or listed in schedules. Silencers shall be as manufactured by Industrial Acoustics Company. Any change in specifications must be submitted in writing to and approved by the Architect/Engineer, at least 10 days prior to bid due-date.

### Materials and Construction

The rectangular jacket outer casing of diffuser silencers shall be constructed from type G-275 galvanised steel in the following minimum gauges based on the smallest diameter of the internal diffuser cone.

The internal diffuser cone shall be constructed from lock former quality type G-275 galvanised perforated steel in the following minimum gauges based on the smallest diameter of the diffuser cone.

Diffuser silencers shall include an internal core of consistent diameter along the entire length in direction of airflow. The core diameter shall be selected based on the adjacent hub diameter or, in the case of C-frame mounted motors, the motor frame size for the respective fan system on which the diffuser silencer is installed. The core shall be constructed from type G-275 galvanised perforated steel in the same gauge as the internal diffuser cone. The core shall be supported by a minimum of three welded radial attachment brackets installed on 120 degree angles to each other to provide uniform support. 100mm long, 3mm thick sleeved end connections shall be provided as standard. When noted, rolled angle flanges shall be welded to the sleeve by the manufacturer. For units where the minimum diffuser cone diameter is 914mm or greater, an additional support rod shall be welded between the radial bracket and the sleeve to prevent a twist from being exerted on the internal core by the airflow of the fan. All welds shall be touched-up with zinc-rich paint after fabrication by the manufacturer.

The internal core and the rectangular outer jacket of diffuser silencers shall be filled with inorganic mineral or glass fibre of a density sufficient to obtain the specified acoustic performance. The fill shall be packed under not less than 5% compression to eliminate voids due to vibration or settling. The fill material shall be inert, vermin and moisture proof. Combustion ratings for the silencer acoustic fill shall be not greater than the following when tested in accordance with ASTM E84, NFPA Standard 255 or UL No.723, Flame Spread Classification – 20, Smoke Development Rating – 20.



## Acoustic Performance

Silencer ratings shall be determined in a duct-to-reverberant room test facility which provides for airflow through the test silencer in accordance with applicable sections of ASTM E 477 and ISO 7235. The test set-up and procedure shall be such that all effects due to end reflection, directivity, flanking transmission, standing waves and test chamber sound absorption are eliminated. Acoustic ratings shall include Dynamic Insertion Loss (DIL) with airflow of at least 10m/s entering face velocity.

## Aerodynamic Performance

Diffuser silencers shall function as pressure regain devices to minimise system pressure losses at the fan. Fan selections are based on the regain performance of the diffuser silencer configuration specified. Any deviations in configuration which adversely affect the fan performance efficiency will not be accepted. Silencers shall not fail structurally when exposed to a differential air pressure of 2000Pa inside to outside the casing.

## Certification

With submittals, the manufacturer shall supply certified dimensional data and acoustic data for Dynamic Insertion Loss. All data shall be for a standard product. All rating tests shall have been constructed in the same facility, utilise the same silencer and be open to inspection upon request from the Architect/Engineer.

## Canary Wharf.

Various duct attenuators and acoustic air handling units supplied

# D-Duct Diffuser Silencer Type: DDS

With Forward and Reverse Flow

The IAC D-Duct (DDS) Diffuser/Silencer is designed for installation at the outlet of vane axial fans. The DDS Silencer has excellent acoustic performance characteristics and at the same time, reduces system pressure drop. The D-Duct Diffuser/Silencer can also be used as an effective inlet cone and silencer.

### Features:

- A combined silencer and diffuser – all in one
- Permits silencing where it is most effective
- Reduces pressure drop
- Easy to handle and install
- Certified performance

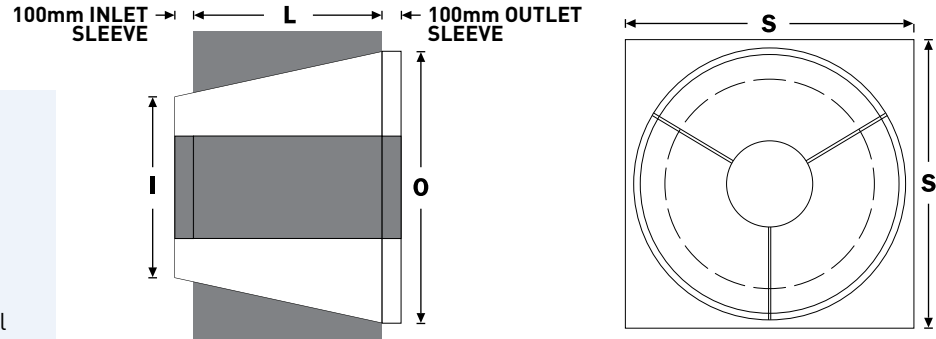

## Dynamic Insertion Loss (DIL) Ratings: Forward (+) / Reverse (-) Flow

| IAC Model | Octave Band | 1  | 2   | 3   | 4   | 5  | 6  | 7  | 8  |
|-----------|-------------|----|-----|-----|-----|----|----|----|----|
|           | Hz          | 63 | 125 | 250 | 500 | 1K | 2K | 4K | 8K |
| 18-A      | -           | 3  | 13  | 22  | 27  | 23 | 17 | 13 |    |
| 20-A      | -           | 2  | 12  | 20  | 26  | 22 | 16 | 12 |    |
| 24-A      | 1           | 4  | 14  | 20  | 24  | 20 | 15 | 12 |    |
| 24-B      | 1           | 5  | 15  | 20  | 25  | 21 | 15 | 12 |    |
| 30-A      | 1           | 7  | 15  | 19  | 21  | 17 | 14 | 12 |    |
| 30-B      | 1           | 8  | 15  | 19  | 21  | 17 | 14 | 12 |    |
| 30-B      | 2           | 8  | 15  | 19  | 21  | 18 | 14 | 12 |    |
| 36-A      | 2           | 8  | 15  | 18  | 17  | 13 | 12 | 11 |    |
| 36-B      | 2           | 9  | 15  | 18  | 17  | 13 | 11 | 10 |    |
| 36-C      | 2           | 9  | 15  | 18  | 18  | 14 | 11 | 10 |    |
| 36-D      | 2           | 9  | 16  | 18  | 19  | 14 | 11 | 10 |    |
| 42-A      | 3           | 10 | 16  | 17  | 16  | 12 | 10 | 9  |    |
| 42-B      | 3           | 10 | 16  | 17  | 16  | 12 | 11 | 10 |    |
| 42-C      | 3           | 10 | 16  | 18  | 16  | 13 | 11 | 10 |    |
| 48-A      | 3           | 11 | 17  | 18  | 16  | 12 | 10 | 10 |    |
| 48-B      | 3           | 11 | 17  | 18  | 16  | 12 | 11 | 10 |    |
| 48-C      | 3           | 11 | 18  | 19  | 17  | 13 | 12 | 10 |    |
| 54-A      | 3           | 11 | 17  | 18  | 16  | 12 | 10 | 10 |    |
| 54-B      | 3           | 11 | 17  | 18  | 16  | 12 | 11 | 10 |    |
| 54-C      | 3           | 11 | 17  | 19  | 17  | 12 | 12 | 10 |    |
| 60-A      | 4           | 12 | 18  | 19  | 14  | 10 | 10 | 10 |    |
| 60-B      | 4           | 12 | 18  | 20  | 16  | 12 | 11 | 10 |    |
| 66-A      | 4           | 12 | 18  | 19  | 14  | 10 | 10 | 10 |    |
| 66-B      | 4           | 12 | 18  | 20  | 16  | 12 | 11 | 10 |    |
| 70-A      | 4           | 12 | 17  | 16  | 12  | 10 | 10 | 10 |    |
| 70-B      | 4           | 12 | 18  | 18  | 15  | 10 | 10 | 10 |    |

## Physical Data

| IAC Model | I Inlet Dia. (mm) | O Outlet Dia. (mm) | S (mm) | L (mm) | Weight (kg) |
|-----------|-------------------|--------------------|--------|--------|-------------|
| 18-A      | 470               | 610                | 711    | 508    | 57          |
| 20-A      | 521               | 711                | 813    | 508    | 64          |
| 24-A      | 622               | 762                | 864    | 610    | 75          |
| 24-B      | 622               | 762                | 864    | 610    | 82          |
| 30-A      | 775               | 1016               | 1118   | 762    | 102         |
| 30-B      | 775               | 1016               | 1118   | 762    | 109         |
| 30-B      | 775               | 1016               | 1118   | 762    | 118         |
| 36-A      | 927               | 1168               | 1270   | 959    | 132         |
| 36-B      | 927               | 1168               | 1270   | 959    | 136         |
| 36-C      | 927               | 1168               | 1270   | 959    | 141         |
| 36-D      | 927               | 1168               | 1270   | 959    | 148         |
| 42-A      | 1080              | 1321               | 1422   | 914    | 182         |
| 42-B      | 1080              | 1321               | 1422   | 914    | 186         |
| 42-C      | 1080              | 1321               | 1422   | 914    | 195         |
| 48-A      | 1232              | 1524               | 1626   | 1105   | 250         |
| 48-B      | 1232              | 1524               | 1626   | 1105   | 264         |
| 48-C      | 1232              | 1524               | 1626   | 1105   | 277         |
| 54-A      | 1403              | 1727               | 1829   | 1219   | 318         |
| 54-B      | 1403              | 1727               | 1829   | 1219   | 341         |
| 54-C      | 1403              | 1727               | 1829   | 1219   | 359         |
| 60-A      | 1549              | 1880               | 1981   | 1340   | 341         |
| 60-B      | 1549              | 1880               | 1981   | 1340   | 359         |
| 66-A      | 1702              | 2083               | 2184   | 1486   | 541         |
| 66-B      | 1702              | 2083               | 2184   | 1486   | 568         |
| 70-A      | 1854              | 2286               | 2388   | 1727   | 636         |
| 70-B      | 1854              | 2286               | 2388   | 1727   | 682         |

## Ducted Discharge

Fan plus DDS Silencer

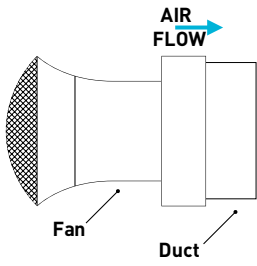

Fan plus 45° (or greater) Transition, No Diffuser

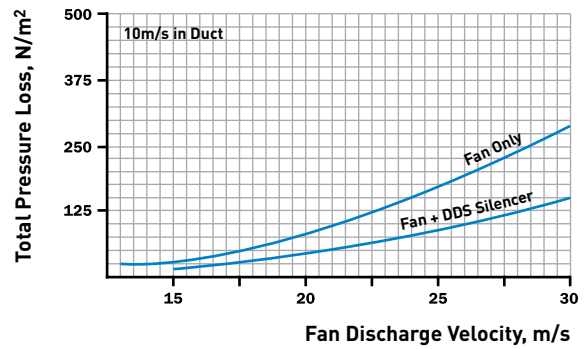
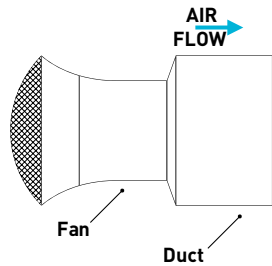

## Discharge into Low Velocity Plenums

Fan plus DDS Silencer at Plenum Entrance

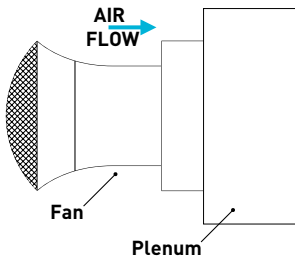

Direct Discharge into Plenum, No Diffuser

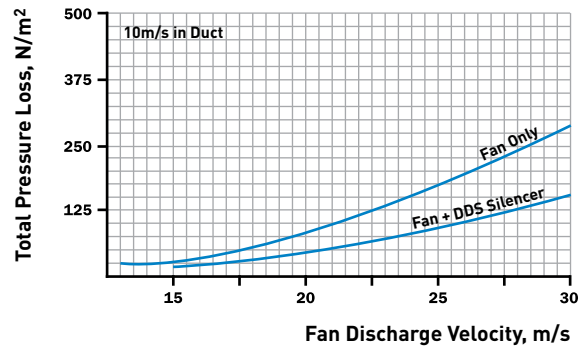
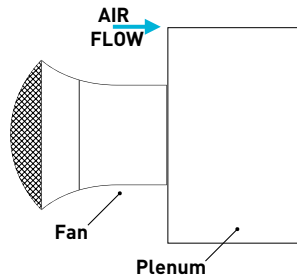

## Free Discharge

Fan Discharge, No Diffuser

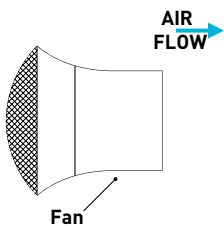

Fan plus DDS Silencer

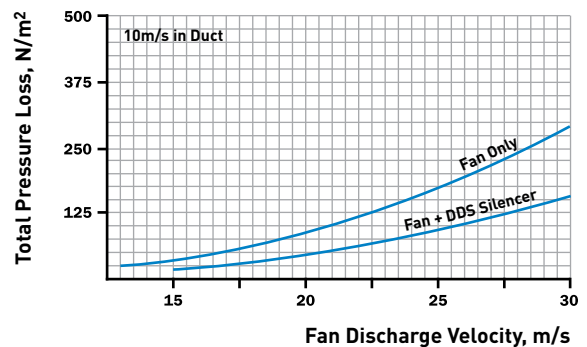
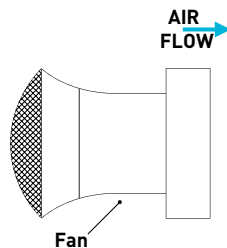

# Specifications:

## Ultra-Pals™ Packless Silencers

### Suitable for ultra-clean environments:

- Chemical plants
- Clean rooms
- Fume cupboards
- Indoor shooting ranges
- Electronics manufacturing
- Food production plants
- Hospital operating theatres
- Forensic laboratories
- Microchip manufacturing plants
- Nuclear processing plants

### General

Furnish and install packless silencers of the models and sizes shown on plans and/or listed in schedule. Silencers shall be the product of Industrial Acoustics Company. Any change in this specification must be submitted in writing to and approved by the Architect/Engineer, in writing, at least 10 days prior to bid due-date.

### Materials and Construction

Unless otherwise specified, silencer modules shall be constructed entirely of galvanised steel in accordance with HVAC DW 144 recommendations for high-pressure rectangular duct-work. Seams shall be lock formed. No sound absorptive material of any kind is to be used in the silencers. Silencers specified shall attenuate air/gas transmitted noise solely by virtue of controlled impedance membranes and broadly tuned resonators. Silencers to be subjected to corrosive environments shall be noted on the schedule as being made of stainless steel or other appropriate material for exposure to a specific gas. Silencers shall not fail structurally when subjected to a differential air pressure of 2000Pa inside or outside of casing.

### Acoustic Performance

Silencer ratings shall be determined in a duct-to-reverberant room test facility which provides for airflow in both directions through the test silencer in accordance with applicable sections of ASTM E 477 and ISO 7235. The test set-up and procedure shall be such that all effects due to end reflections, directivity, flanking transmission, standing waves and test chamber sound absorption are eliminated. Acoustic ratings shall include Dynamic Insertion Loss (DIL) and self-noise power levels both for forward and reverse flow. Data shall be presented for tests conducted using silencers no smaller than 600mm x 600mm or 750mm x 600mm.



## Aerodynamic Performance

Static pressure loss of silencers shall not exceed those listed in the silencer schedule at the airflow indicated. Airflow measurements shall be made in accordance with ASTM Specification E 477 and applicable portions of ASME, AMCA and ADC airflow test codes. Tests shall be reported on the identical units for which acoustic data is presented.

## Certification

With submittals, the manufacturer shall supply certified test data on Dynamic Insertion Loss (DIL), self-noise power levels, and aerodynamic performance for reverse and forward test conditions. Test data shall be for a standard product. All rating test shall be conducted in the same facility, utilise the same silencer, and be open to inspection upon request from the Architect/Engineer.

# Ultra-pals™ Packless Silencers Type: XM

With Forward and Reverse Flow Ratings

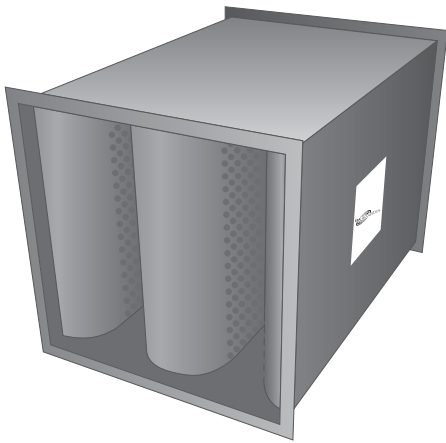

The complete absence of fill combined with ease of cleaning and draining, makes packless silencers well suited for chemical plants, refineries, nuclear power plants and facilities handling petrol, grease, solvents or other hazardous materials.

### Supplied as Standard:

- Aerodynamic inlet and discharge to splitter elements to reduce pressure drop and conserve energy

### Designating Silencers: Example

Model: 6XM-600x600

| Length | Type | Width | Height |
|--------|------|-------|--------|
| 1800mm | XM   | 600mm | 600mm  |

- No Fibreglass
- No Foam
- No Mineral Wool
- No Fill of Any Kind

## Self-Noise Power Levels dB re: 10<sup>-12</sup> Watts

| IAC XM Model             | Octave Band                 | 1  | 2   | 3   | 4   | 5  | 6  | 7  | 8  |
|--------------------------|-----------------------------|----|-----|-----|-----|----|----|----|----|
|                          | Hz                          | 63 | 125 | 250 | 500 | 1K | 2K | 4K | 8K |
|                          | Silencer Face Velocity, m/s |    |     |     |     |    |    |    |    |
| 3XM                      | -7.5                        | 54 | 52  | 56  | 58  | 59 | 64 | 65 | 58 |
|                          | -5                          | 42 | 44  | 49  | 51  | 55 | 59 | 55 | 45 |
|                          | +5                          | 46 | 42  | 44  | 46  | 52 | 57 | 55 | 52 |
|                          | +7.5                        | 54 | 54  | 57  | 54  | 54 | 62 | 65 | 59 |
| 6XM & 9XM All Sizes (mm) | -10                         | 64 | 61  | 58  | 59  | 60 | 64 | 67 | 64 |
|                          | -5                          | 56 | 52  | 52  | 52  | 55 | 61 | 60 | 50 |
|                          | +5                          | 58 | 54  | 49  | 46  | 52 | 60 | 60 | 50 |
|                          | +10                         | 66 | 67  | 65  | 61  | 58 | 63 | 69 | 67 |

## Aerodynamic Performance

| IAC Model                   | Length (mm) | Static Pressure Drop N/m <sup>2</sup> |      |      |      |      |      |      |      |
|-----------------------------|-------------|---------------------------------------|------|------|------|------|------|------|------|
|                             |             | 5                                     | 7    | 10   | 15   | 17   | 22   | 27   | 32   |
| XM                          | 900         | 5                                     | 7    | 10   | 15   | 17   | 22   | 27   | 32   |
|                             | 1800        | 7                                     | 10   | 15   | 20   | 25   | 30   | 37   | 42   |
|                             | 2700        | 10                                    | 12   | 17   | 25   | 30   | 37   | 45   | 55   |
| Silencer Face Velocity, m/s |             | 1.27                                  | 1.52 | 1.78 | 2.03 | 2.29 | 2.54 | 2.79 | 3.05 |

## Face Area Adjustment Factors (add or subtract from Lw values above)

|  |      |      |      |      |      |      |      |       |
|--|------|------|------|------|------|------|------|-------|
| <b>Ultra-Pals™ Face Area, m<sup>2</sup>*</b> | 0.09 | 0.19 | 0.37 | 0.74 | 1.50 | 3.00 | 6.00 | 12.00 |
| <b>Lw Adjustment Factor, dB</b>              | -6   | -3   | 0    | +3   | +6   | +9   | +12  | +15   |

\* For intermediate face areas, interpolate to the nearest whole number

## Dynamic Insertion Loss (DIL) Ratings: Forward (+) / Reverse (-) Flow

| IAC XM Model (length in mm) | Octave Band                 | 1  | 2   | 3   | 4   | 5  | 6  | 7  | 8  |
|-----------------------------|-----------------------------|----|-----|-----|-----|----|----|----|----|
|                             | Hz                          | 63 | 125 | 250 | 500 | 1K | 2K | 4K | 8K |
|                             | Silencer Face Velocity, m/s |    |     |     |     |    |    |    |    |
| <b>3XM (900)</b>            | -7.5                        | 6  | 8   | 12  | 18  | 22 | 13 | 10 | 7  |
|                             | -5                          | 6  | 6   | 10  | 17  | 20 | 12 | 9  | 8  |
|                             | 0                           | 4  | 4   | 7   | 15  | 17 | 11 | 10 | 9  |
|                             | +5                          | 6  | 4   | 10  | 17  | 20 | 12 | 10 | 9  |
|                             | +7.5                        | 5  | 5   | 11  | 17  | 23 | 13 | 10 | 8  |
| <b>6XM (1800)</b>           | -7.5                        | 10 | 15  | 23  | 33  | 30 | 16 | 11 | 10 |
|                             | -5                          | 9  | 12  | 17  | 30  | 25 | 14 | 12 | 11 |
|                             | 0                           | 5  | 7   | 11  | 25  | 22 | 14 | 13 | 12 |
|                             | +5                          | 7  | 9   | 15  | 27  | 25 | 14 | 14 | 12 |
|                             | +7.5                        | 7  | 11  | 17  | 30  | 29 | 16 | 14 | 13 |
| <b>9XM (2700)</b>           | -7.5                        | 12 | 22  | 32  | 39  | 38 | 21 | 16 | 13 |
|                             | -5                          | 10 | 19  | 26  | 36  | 31 | 19 | 18 | 16 |
|                             | 0                           | 7  | 12  | 15  | 31  | 27 | 19 | 18 | 17 |
|                             | +5                          | 8  | 16  | 22  | 35  | 29 | 20 | 19 | 18 |
|                             | +7.5                        | 7  | 17  | 25  | 38  | 34 | 22 | 18 | 17 |

### Note

- Silencer Face Area is the cross-sectional area at the silencer entrance
- Face Velocity is the airflow (m<sup>3</sup>/s) divided by the Face Area (m<sup>2</sup>)
- Pressure drop for any face velocity can be calculated from the equation:  
 $PD = (\text{Actual FV} / \text{catalogue FV})^2 \times (\text{Catalogue PD})$
- Self Noise values shown are for a 0.37m<sup>2</sup> face area silencer
- For each doubling of face area add 3dB to the self noise values listed
- For each halving of face area subtract 3dB from the self noise values listed

# Ultra-pals™ Packless Silencers Type: XL

With Forward and Reverse Flow Ratings

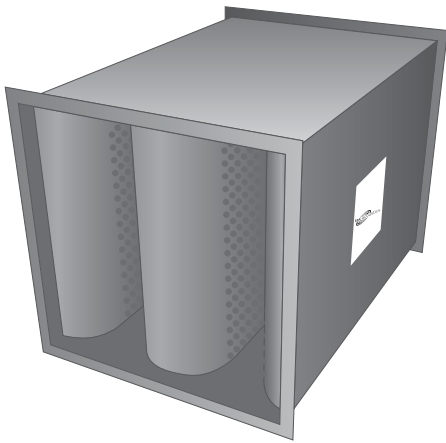

The complete absence of fill combined with ease of cleaning and draining, makes packless silencers well suited for chemical plants, refineries, nuclear power plants and facilities handling petrol, grease, solvents or other hazardous materials.

### Supplied as Standard:

- Aerodynamic inlet and discharge to splitter elements to reduce pressure drop and conserve energy

### Designating Silencers: Example

Model: 6XL-600x600

| Length | Type | Width | Height |
|--------|------|-------|--------|
| 1800mm | XL   | 600mm | 600mm  |

- No Fibreglass
- No Foam
- No Mineral Wool
- No Fill of Any Kind

## Self-Noise Power Levels dB re: 10<sup>-12</sup> Watts

| IAC XL Model             | Octave Band                 | 1  | 2   | 3   | 4   | 5  | 6  | 7  | 8  |
|--------------------------|-----------------------------|----|-----|-----|-----|----|----|----|----|
|                          | Hz                          | 63 | 125 | 250 | 500 | 1K | 2K | 4K | 8K |
|                          | Silencer Face Velocity, m/s |    |     |     |     |    |    |    |    |
| 3XL                      | -7.5                        | 54 | 52  | 56  | 58  | 59 | 64 | 65 | 58 |
|                          | -5                          | 42 | 44  | 49  | 51  | 55 | 59 | 55 | 45 |
|                          | +5                          | 46 | 42  | 44  | 46  | 52 | 57 | 55 | 52 |
|                          | +7.5                        | 54 | 54  | 57  | 54  | 54 | 62 | 65 | 59 |
| 6XL & 9XL All Sizes (mm) | -10                         | 64 | 61  | 58  | 59  | 60 | 64 | 67 | 64 |
|                          | -5                          | 56 | 52  | 52  | 52  | 55 | 61 | 60 | 50 |
|                          | +5                          | 58 | 54  | 49  | 46  | 52 | 60 | 60 | 50 |
|                          | +10                         | 66 | 67  | 65  | 61  | 58 | 63 | 69 | 67 |

## Aerodynamic Performance

| IAC Model                   | Length (mm) | Static Pressure Drop N/m <sup>2</sup> |      |      |      |      |      |      |      |
|-----------------------------|-------------|---------------------------------------|------|------|------|------|------|------|------|
|                             |             | 7                                     | 10   | 15   | 20   | 25   | 30   | 37   | 42   |
| XL                          | 900         | 7                                     | 10   | 15   | 20   | 25   | 30   | 37   | 42   |
|                             | 1800        | 10                                    | 12   | 17   | 25   | 30   | 37   | 45   | 55   |
|                             | 2700        | 10                                    | 15   | 22   | 27   | 35   | 45   | 55   | 65   |
| Silencer Face Velocity, m/s |             | 1.27                                  | 1.52 | 1.78 | 2.03 | 2.29 | 2.54 | 2.79 | 3.05 |



## Face Area Adjustment Factors (add or subtract from Lw values above)

|  |      |      |      |      |      |      |      |       |
|--|------|------|------|------|------|------|------|-------|
| <b>Ultra-Pals™ Face Area, m<sup>2</sup>*</b> | 0.09 | 0.19 | 0.37 | 0.74 | 1.50 | 3.00 | 6.00 | 12.00 |
| <b>Lw Adjustment Factor, dB</b>              | -6   | -3   | 0    | +3   | +6   | +9   | +12  | +15   |

\* For intermediate face areas, interpolate to the nearest whole number

## Dynamic Insertion Loss (DIL) Ratings: Forward (+) / Reverse (-) Flow

| IAC XL Model (length in mm) | Octave Band                 | 1  | 2   | 3   | 4   | 5  | 6  | 7  | 8  |
|-----------------------------|-----------------------------|----|-----|-----|-----|----|----|----|----|
|                             | Hz                          | 63 | 125 | 250 | 500 | 1K | 2K | 4K | 8K |
|                             | Silencer Face Velocity, m/s |    |     |     |     |    |    |    |    |
| <b>3XL (900)</b>            | -7.5                        | 9  | 12  | 18  | 21  | 13 | 11 | 9  | 7  |
|                             | -5                          | 8  | 10  | 16  | 20  | 12 | 11 | 9  | 7  |
|                             | 0                           | 8  | 7   | 15  | 17  | 11 | 11 | 9  | 8  |
|                             | +5                          | 7  | 8   | 17  | 21  | 13 | 11 | 9  | 8  |
|                             | +7.5                        | 7  | 9   | 18  | 21  | 14 | 13 | 9  | 9  |
| <b>6XL (1800)</b>           | -7.5                        | 12 | 20  | 25  | 30  | 19 | 16 | 13 | 10 |
|                             | -5                          | 12 | 18  | 23  | 27  | 18 | 15 | 13 | 10 |
|                             | 0                           | 8  | 11  | 19  | 23  | 16 | 14 | 13 | 11 |
|                             | +5                          | 11 | 14  | 23  | 28  | 19 | 15 | 13 | 12 |
|                             | +7.5                        | 10 | 15  | 24  | 30  | 21 | 17 | 14 | 12 |
| <b>9XL (2700)</b>           | -7.5                        | 19 | 28  | 32  | 38  | 27 | 21 | 16 | 11 |
|                             | -5                          | 16 | 25  | 29  | 34  | 24 | 19 | 16 | 12 |
|                             | 0                           | 11 | 15  | 22  | 27  | 20 | 18 | 16 | 15 |
|                             | +5                          | 13 | 20  | 29  | 33  | 25 | 20 | 16 | 16 |
|                             | +7.5                        | 13 | 21  | 29  | 35  | 26 | 23 | 18 | 15 |

### Note

- Silencer Face Area is the cross-sectional area at the silencer entrance
- Face Velocity is the airflow (m<sup>3</sup>/s) divided by the Face Area (m<sup>2</sup>)
- Pressure drop for any face velocity can be calculated from the equation:  
 $PD = (\text{Actual FV} / \text{catalogue FV})^2 \times (\text{Catalogue PD})$
- Self Noise values shown are for a 0.37m<sup>2</sup> face area silencer
- For each doubling of face area add 3dB to the self noise values listed
- For each halving of face area subtract 3dB from the self noise values listed

# Ultra-pals™ Packless Silencers Type: KM

With Forward and Reverse Flow Ratings

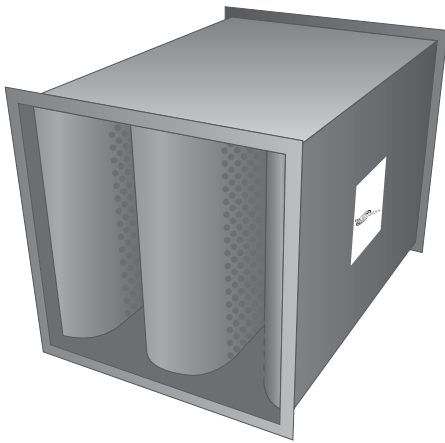

The complete absence of fill combined with ease of cleaning and draining, makes packless silencers well suited for chemical plants, refineries, nuclear power plants and facilities handling petrol, grease, solvents or other hazardous materials.

### Supplied as Standard:

- Aerodynamic inlet and discharge to splitter elements to reduce pressure drop and conserve energy

### Designating Silencers: Example

Model: 6KM-750x600

| Length | Type | Width | Height |
|--------|------|-------|--------|
| 1800mm | KM   | 750mm | 600mm  |

- No Fibreglass
- No Foam
- No Mineral Wool
- No Fill of Any Kind

## Self-Noise Power Levels dB re: 10<sup>-12</sup> Watts

| IAC KM Model | Octave Band                 | 1  | 2   | 3   | 4   | 5  | 6  | 7  | 8  |
|--------------|-----------------------------|----|-----|-----|-----|----|----|----|----|
|              | Hz                          | 63 | 125 | 250 | 500 | 1K | 2K | 4K | 8K |
|              | Silencer Face Velocity, m/s |    |     |     |     |    |    |    |    |
| 3KM          | -7.5                        | 49 | 51  | 54  | 58  | 59 | 63 | 63 | 54 |
|              | -5                          | 38 | 38  | 42  | 47  | 51 | 48 | 41 | 35 |
|              | +5                          | 36 | 36  | 38  | 43  | 49 | 46 | 38 | 35 |
|              | +7.5                        | 53 | 49  | 50  | 51  | 54 | 62 | 63 | 54 |
| 6KM & 9KM    | -10                         | 54 | 55  | 55  | 57  | 58 | 62 | 62 | 54 |
|              | -5                          | 44 | 50  | 44  | 51  | 52 | 49 | 40 | 24 |
|              | +5                          | 52 | 43  | 40  | 44  | 50 | 50 | 42 | 25 |
|              | +10                         | 58 | 58  | 54  | 53  | 55 | 64 | 66 | 59 |

## Aerodynamic Performance

| IAC Model                   | Length (mm) | Static Pressure Drop N/m <sup>2</sup> |      |      |      |      |      |      |      |
|-----------------------------|-------------|---------------------------------------|------|------|------|------|------|------|------|
|                             |             | 7                                     | 10   | 12   | 17   | 22   | 27   | 32   | 37   |
| KM                          | 900         | 7                                     | 10   | 12   | 17   | 22   | 27   | 32   | 37   |
|                             | 1800        | 7                                     | 10   | 15   | 20   | 25   | 30   | 37   | 45   |
|                             | 2700        | 10                                    | 12   | 17   | 22   | 30   | 35   | 42   | 50   |
| Silencer Face Velocity, m/s |             | 2.54                                  | 3.05 | 3.56 | 4.06 | 4.57 | 5.08 | 5.59 | 6.10 |

## Face Area Adjustment Factors (add or subtract from Lw values above)

|  |      |      |      |      |      |      |      |       |
|--|------|------|------|------|------|------|------|-------|
| <b>Ultra-Pals™ Face Area, m<sup>2</sup>*</b> | 0.12 | 0.23 | 0.46 | 0.93 | 2.00 | 4.00 | 7.50 | 15.00 |
| <b>Lw Adjustment Factor, dB</b>              | -6   | -3   | 0    | +3   | +6   | +9   | +12  | +15   |

\* For intermediate face areas, interpolate to the nearest whole number

## Dynamic Insertion Loss (DIL) Ratings: Forward (+) / Reverse (-) Flow

| IAC KM Model (length in mm) | Octave Band                 | 1  | 2   | 3   | 4   | 5  | 6  | 7  | 8  |
|-----------------------------|-----------------------------|----|-----|-----|-----|----|----|----|----|
|                             | Hz                          | 63 | 125 | 250 | 500 | 1K | 2K | 4K | 8K |
|                             | Silencer Face Velocity, m/s |    |     |     |     |    |    |    |    |
| <b>3KM (900)</b>            | -7.5                        | 4  | 5   | 10  | 16  | 14 | 10 | 7  | 7  |
|                             | -5                          | 3  | 3   | 7   | 13  | 12 | 8  | 7  | 7  |
|                             | 0                           | 3  | 2   | 5   | 12  | 11 | 7  | 7  | 6  |
|                             | +5                          | 3  | 3   | 6   | 13  | 11 | 7  | 6  | 5  |
|                             | +7.5                        | 3  | 4   | 7   | 14  | 14 | 8  | 6  | 5  |
| <b>6KM (1800)</b>           | -7.5                        | 9  | 9   | 17  | 24  | 21 | 9  | 9  | 8  |
|                             | -5                          | 8  | 5   | 12  | 19  | 16 | 8  | 9  | 8  |
|                             | 0                           | 5  | 4   | 9   | 18  | 15 | 9  | 9  | 8  |
|                             | +5                          | 6  | 4   | 10  | 19  | 16 | 9  | 9  | 7  |
|                             | +7.5                        | 7  | 5   | 13  | 23  | 20 | 10 | 9  | 8  |
| <b>9KM (2700)</b>           | -7.5                        | 12 | 12  | 23  | 33  | 25 | 12 | 12 | 10 |
|                             | -5                          | 10 | 8   | 16  | 27  | 20 | 11 | 13 | 10 |
|                             | 0                           | 9  | 6   | 12  | 25  | 20 | 12 | 12 | 11 |
|                             | +5                          | 9  | 7   | 15  | 26  | 21 | 12 | 12 | 10 |
|                             | +7.5                        | 8  | 9   | 18  | 31  | 25 | 14 | 12 | 10 |

### Note

- Silencer Face Area is the cross-sectional area at the silencer entrance
- Face Velocity is the airflow (m<sup>3</sup>/s) divided by the Face Area (m<sup>2</sup>)
- Pressure drop for any face velocity can be calculated from the equation:  
 $PD = (\text{Actual FV} / \text{catalogue FV})^2 \times (\text{Catalogue PD})$
- Self Noise values shown are for a 0.46m<sup>2</sup> face area silencer
- For each doubling of face area add 3dB to the self noise values listed
- For each halving of face area subtract 3dB from the self noise values listed

# Ultra-pals™ Packless Silencers Type: KL

With Forward and Reverse Flow Ratings

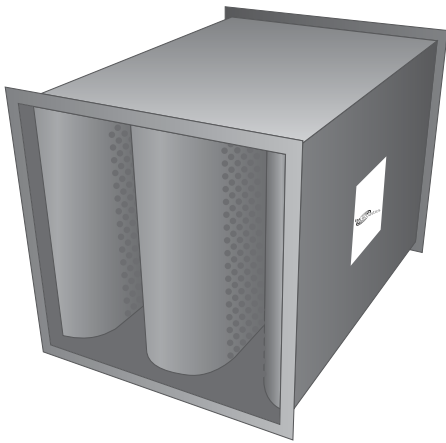

The complete absence of fill combined with ease of cleaning and draining, makes packless silencers well suited for chemical plants, refineries, nuclear power plants and facilities handling petrol, grease, solvents or other hazardous materials.

### Supplied as Standard:

- Aerodynamic inlet and discharge to splitter elements to reduce pressure drop and conserve energy

### Designating Silencers: Example

Model: 6KL-750x600

| Length | Type | Width | Height |
|--------|------|-------|--------|
| 1800mm | KL   | 750mm | 600mm  |

- No Fibreglass
- No Foam
- No Mineral Wool
- No Fill of Any Kind

## Self-Noise Power Levels dB re: 10-12 Watts

| IAC KL Model | Octave Band                 | 1  | 2   | 3   | 4   | 5  | 6  | 7  | 8  |
|--------------|-----------------------------|----|-----|-----|-----|----|----|----|----|
|              | Hz                          | 63 | 125 | 250 | 500 | 1K | 2K | 4K | 8K |
|              | Silencer Face Velocity, m/s |    |     |     |     |    |    |    |    |
| 3KL          | -7.5                        | 49 | 51  | 54  | 58  | 59 | 63 | 63 | 54 |
|              | -5                          | 38 | 38  | 42  | 47  | 51 | 48 | 41 | 35 |
|              | +5                          | 36 | 36  | 38  | 43  | 49 | 46 | 38 | 35 |
|              | +7.5                        | 53 | 49  | 50  | 51  | 54 | 62 | 63 | 54 |
| 6KL & 9KL    | -10                         | 54 | 55  | 55  | 57  | 58 | 62 | 62 | 54 |
|              | -5                          | 44 | 50  | 44  | 51  | 52 | 49 | 40 | 24 |
|              | +5                          | 52 | 43  | 40  | 44  | 50 | 50 | 42 | 25 |
|              | +10                         | 58 | 58  | 54  | 53  | 55 | 64 | 66 | 59 |

## Aerodynamic Performance

| IAC Model                   | Length (mm) | Static Pressure Drop N/m <sup>2</sup> |      |      |      |      |      |      |      |
|-----------------------------|-------------|---------------------------------------|------|------|------|------|------|------|------|
|                             |             | 7                                     | 12   | 15   | 20   | 27   | 32   | 40   | 47   |
| KL                          | 900         | 7                                     | 12   | 15   | 20   | 27   | 32   | 40   | 47   |
|                             | 1800        | 10                                    | 12   | 17   | 25   | 30   | 37   | 45   | 55   |
|                             | 2700        | 12                                    | 15   | 22   | 30   | 37   | 45   | 55   | 65   |
| Silencer Face Velocity, m/s |             | 2.54                                  | 3.05 | 3.56 | 4.06 | 4.57 | 5.08 | 5.59 | 6.10 |

## Face Area Adjustment Factors (add or subtract from Lw values above)

|  |      |      |      |      |      |      |      |       |
|--|------|------|------|------|------|------|------|-------|
| <b>Ultra-Pals™ Face Area, m<sup>2</sup>*</b> | 0.12 | 0.23 | 0.46 | 0.93 | 2.00 | 4.00 | 7.50 | 15.00 |
| <b>Lw Adjustment Factor, dB</b>              | -6   | -3   | 0    | +3   | +6   | +9   | +12  | +15   |

\* For intermediate face areas, interpolate to the nearest whole number

## Dynamic Insertion Loss (DIL) Ratings: Forward (+) / Reverse (-) Flow

| IAC KL Model (length in mm) | Octave Band                 | 1  | 2   | 3   | 4   | 5  | 6  | 7  | 8  |
|-----------------------------|-----------------------------|----|-----|-----|-----|----|----|----|----|
|                             | Hz                          | 63 | 125 | 250 | 500 | 1K | 2K | 4K | 8K |
|                             | Silencer Face Velocity, m/s |    |     |     |     |    |    |    |    |
| <b>3KL (900)</b>            | -7.5                        | 7  | 9   | 16  | 14  | 11 | 8  | 7  | 6  |
|                             | -5                          | 4  | 6   | 14  | 12  | 8  | 7  | 7  | 6  |
|                             | 0                           | 5  | 4   | 11  | 9   | 7  | 7  | 7  | 5  |
|                             | +5                          | 4  | 5   | 13  | 11  | 7  | 7  | 6  | 4  |
|                             | +7.5                        | 5  | 7   | 15  | 13  | 10 | 8  | 7  | 5  |
| <b>6KL (1800)</b>           | -7.5                        | 9  | 10  | 22  | 16  | 11 | 9  | 8  | 9  |
|                             | -5                          | 7  | 8   | 18  | 14  | 10 | 9  | 8  | 9  |
|                             | 0                           | 6  | 6   | 16  | 14  | 9  | 9  | 9  | 8  |
|                             | +5                          | 6  | 7   | 18  | 14  | 10 | 9  | 8  | 8  |
|                             | +7.5                        | 8  | 8   | 21  | 16  | 12 | 10 | 8  | 7  |
| <b>9KL (2700)</b>           | -7.5                        | 13 | 15  | 28  | 19  | 15 | 10 | 10 | 9  |
|                             | -5                          | 11 | 11  | 24  | 17  | 13 | 10 | 10 | 9  |
|                             | 0                           | 9  | 9   | 20  | 17  | 12 | 11 | 10 | 9  |
|                             | +5                          | 10 | 9   | 24  | 17  | 13 | 11 | 10 | 8  |
|                             | +7.5                        | 11 | 11  | 28  | 19  | 15 | 12 | 10 | 8  |

### Note

- Silencer Face Area is the cross-sectional area at the silencer entrance
- Face Velocity is the airflow (m<sup>3</sup>/s) divided by the Face Area (m<sup>2</sup>)
- Pressure drop for any face velocity can be calculated from the equation:  
 $PD = (\text{Actual FV} / \text{catalogue FV})^2 \times (\text{Catalogue PD})$
- Self Noise values shown are for a 0.46m<sup>2</sup> face area silencer
- For each doubling of face area add 3dB to the self noise values listed
- For each halving of face area subtract 3dB from the self noise values listed

# Ultra-pals™ Packless Silencers Type: TXS / TXL

With Forward and Reverse Flow Ratings

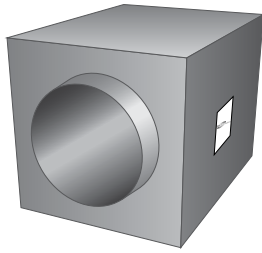

Designed primarily for use in fume hood applications, the complete absence of fill combined with ease of cleaning and draining makes TXS/TXL tubular packless silencers ideally suited for chemical plants, refineries, nuclear power plants and facilities handling petrol, grease, solvents, or other hazardous materials.

### Supplied as Standard:

- Aerodynamic inlet and discharge to splitter elements to reduce pressure drop and conserve energy

- No Fibreglass
- No Foam
- No Mineral Wool
- No Fill of Any Kind

### Designating Silencers: Example

Model: 200TXS or 200TXL-914

| Pipe Diameter | Type       | Length |
|---------------|------------|--------|
| 200mm         | TXS or TXL | 914mm  |

## Self-Noise Power Levels dB re: 10<sup>-12</sup> Watts

| IAC TXS Model | Octave Band                 | 1  | 2   | 3   | 4   | 5  | 6  | 7  | 8  |
|---------------|-----------------------------|----|-----|-----|-----|----|----|----|----|
|               | Hz                          | 63 | 125 | 250 | 500 | 1K | 2K | 4K | 8K |
|               | Silencer Face Velocity, m/s |    |     |     |     |    |    |    |    |
| TXS           | -10                         | 54 | 47  | 49  | 47  | 51 | 50 | 46 | 38 |
|               | -5                          | 20 | 35  | 37  | 37  | 37 | 32 | 20 | 20 |
|               | +5                          | 20 | 34  | 35  | 35  | 35 | 28 | 20 | 20 |
|               | +10                         | 54 | 47  | 45  | 45  | 49 | 50 | 45 | 34 |

## Dynamic Insertion Loss (DIL) Ratings: Forward (+) / Reverse (-) Flow

| IAC TXS Model (length in mm) | Octave Band                 | 1  | 2   | 3   | 4   | 5  | 6  | 7  | 8  |
|------------------------------|-----------------------------|----|-----|-----|-----|----|----|----|----|
|                              | Hz                          | 63 | 125 | 250 | 500 | 1K | 2K | 4K | 8K |
|                              | Silencer Face Velocity, m/s |    |     |     |     |    |    |    |    |
| 200TXS (914)                 | -10                         | 15 | 20  | 26  | 17  | 12 | 12 | 12 | 7  |
|                              | -5                          | 15 | 18  | 26  | 16  | 11 | 12 | 12 | 8  |
|                              | 0                           | 15 | 18  | 26  | 16  | 10 | 12 | 12 | 8  |
|                              | +5                          | 15 | 18  | 26  | 16  | 10 | 12 | 11 | 7  |
|                              | +10                         | 15 | 19  | 26  | 18  | 12 | 11 | 11 | 6  |
| 300TXS (914)                 | -10                         | 11 | 13  | 23  | 25  | 18 | 12 | 13 | 9  |
|                              | -5                          | 9  | 11  | 19  | 22  | 14 | 11 | 13 | 9  |
|                              | 0                           | 7  | 8   | 17  | 20  | 13 | 10 | 11 | 8  |
|                              | +5                          | 7  | 8   | 17  | 20  | 13 | 10 | 11 | 8  |
|                              | +10                         | 7  | 8   | 18  | 22  | 15 | 10 | 11 | 8  |

## Self-Noise Power Levels dB re: 10<sup>-12</sup> Watts

| IAC TXL Model | Octave Band                 | 1  | 2   | 3   | 4   | 5  | 6  | 7  | 8  |
|---------------|-----------------------------|----|-----|-----|-----|----|----|----|----|
|               | Hz                          | 63 | 125 | 250 | 500 | 1K | 2K | 4K | 8K |
|               | Silencer Face Velocity, m/s |    |     |     |     |    |    |    |    |
| TXL           | -10                         | 20 | 33  | 37  | 39  | 36 | 31 | 20 | 20 |
|               | -5                          | 20 | 20  | 25  | 25  | 23 | 20 | 20 | 20 |
|               | +5                          | 20 | 22  | 28  | 28  | 25 | 20 | 20 | 20 |
|               | +10                         | 20 | 35  | 42  | 41  | 35 | 29 | 20 | 20 |

## Dynamic Insertion Loss (DIL) Ratings: Forward (+) / Reverse (-) Flow

| IAC TXL Model (length in mm) | Octave Band                 | 1  | 2   | 3   | 4   | 5  | 6  | 7  | 8  |
|------------------------------|-----------------------------|----|-----|-----|-----|----|----|----|----|
|                              | Hz                          | 63 | 125 | 250 | 500 | 1K | 2K | 4K | 8K |
|                              | Silencer Face Velocity, m/s |    |     |     |     |    |    |    |    |
| 200TXL (914)                 | -10                         | 13 | 16  | 25  | 16  | 9  | 7  | 6  | 4  |
|                              | -5                          | 13 | 16  | 25  | 15  | 8  | 7  | 6  | 3  |
|                              | 0                           | 13 | 15  | 25  | 14  | 8  | 7  | 6  | 3  |
|                              | +5                          | 13 | 15  | 25  | 14  | 8  | 7  | 6  | 4  |
|                              | +10                         | 12 | 15  | 25  | 15  | 8  | 7  | 6  | 4  |
| 300TXL (914)                 | -10                         | 5  | 8   | 16  | 16  | 7  | 6  | 5  | 4  |
|                              | -5                          | 5  | 8   | 16  | 16  | 7  | 6  | 5  | 4  |
|                              | 0                           | 4  | 8   | 16  | 16  | 7  | 7  | 5  | 3  |
|                              | +5                          | 4  | 8   | 16  | 16  | 7  | 7  | 5  | 3  |
|                              | +10                         | 5  | 8   | 16  | 17  | 7  | 7  | 5  | 3  |

## Physical & Aerodynamic Performance Data

| IAC Model                                 | Pipe Diam. | Width (mm) | Height (mm) | Length (mm) | Weight (kg) | Static Pressure Drop N/m <sup>2</sup> |      |       |       |      |       |       |       |
|---|------------|------------|-------------|-------------|-------------|---------------------------------------|------|-------|-------|------|-------|-------|-------|
|   |            |            |             |             |             | 1                                     | 2    | 3     | 4     | 5    | 6     | 7     | 8     |
| TXL                                       | 200        | 533        | 533         | 914         | 14          | 10                                    | 12   | 17    | 20    | 25   | 30    | 37    | 42    |
|   | 300        | 533        | 533         | 914         | 16          | 10                                    | 12   | 15    | 20    | 25   | 30    | 35    | 42    |
| Silencer Face Velocity, m <sup>3</sup> /s |            |            |             |             |             | 7.62                                  | 8.89 | 10.16 | 11.43 | 12.7 | 13.97 | 15.24 | 16.51 |
| TXS                                       | 200        | 533        | 533         | 914         | 14          | 37                                    | 50   | 65    | 82    | 102  | 125   | 147   | 172   |
|   | 300        | 533        | 533         | 914         | 16          | 35                                    | 47   | 62    | 80    | 97   | 117   | 139   | 164   |
| Silencer Face Velocity, m/s               |            |            |             |             |             | 7.62                                  | 8.89 | 10.16 | 11.43 | 12.7 | 13.97 | 15.24 | 16.51 |

### Note

- Silencer Face Area is the cross-sectional area at the silencer entrance
- Face Velocity is the airflow (m<sup>3</sup>/s) divided by the Face Area (m<sup>2</sup>)
- Pressure drop for any face velocity can be calculated from the equation:  
 $PD = (\text{Actual FV} / \text{catalogue FV})^2 \times (\text{Catalogue PD})$

# Ultra-pals™ Packless Silencers Type: TXLB (Elbow)

With Forward and Reverse Flow Ratings

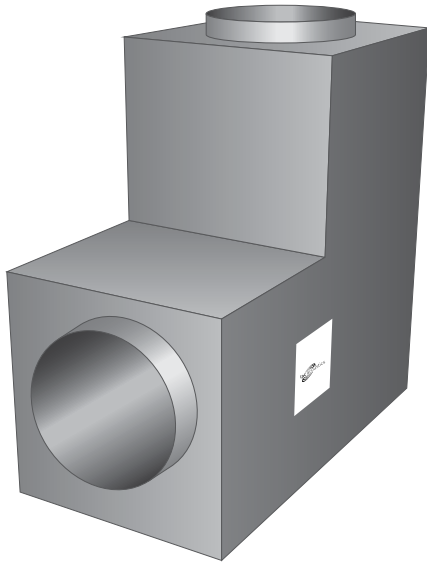

Designed primarily for use in fume hood applications, the complete absence of fill combined with ease of cleaning and draining makes TXLB tubular packless silencers ideally suited for chemical plants, refineries, nuclear power plants and facilities handling petrol, grease, solvents, or other hazardous materials. The elbow configuration makes for a compact arrangement suitable for low head-room or other tight space installations.

#### Supplied as Standard:

- Aerodynamic inlet and discharge to splitter elements to reduce pressure drop and conserve energy

#### Designating Silencers: Example

Model: 200TXLB-914

| Pipe Diameter | Type | Length |
|---------------|------|--------|
| 200mm         | TXLB | 914mm  |

- No Fibreglass
- No Foam
- No Mineral Wool
- No Fill of Any Kind

## Self-Noise Power Levels dB re: 10<sup>-12</sup> Watts

| IAC TXLB Model (length in mm) | Octave Band                               | 1  | 2   | 3   | 4   | 5  | 6  | 7  | 8  |
|-------------------------------|---|----|-----|-----|-----|----|----|----|----|
|                               | Hz  | 63 | 125 | 250 | 500 | 1K | 2K | 4K | 8K |
|                               | Silencer Face Velocity, m <sup>3</sup> /s |    |     |     |     |    |    |    |    |
| 200TXLB (914)                 | -10                                       | 50 | 43  | 40  | 40  | 41 | 43 | 40 | 31 |
|                               | -5  | 42 | 32  | 32  | 26  | 23 | 20 | 20 | 20 |
|                               | +5  | 42 | 29  | 27  | 32  | 30 | 23 | 21 | 20 |
|                               | +10                                       | 51 | 43  | 41  | 43  | 45 | 49 | 45 | 33 |
| 300TXLB (914)                 | -10                                       | 58 | 44  | 42  | 44  | 46 | 48 | 47 | 38 |
|                               | -5  | 50 | 40  | 34  | 35  | 31 | 27 | 20 | 20 |
|                               | +5  | 52 | 38  | 34  | 34  | 35 | 27 | 20 | 20 |
|                               | +10                                       | 62 | 47  | 43  | 45  | 49 | 52 | 49 | 38 |



## Physical & Aerodynamic Performance Data

| IAC Model                          | Pipe Diam. | Width (mm) | Height (mm) | Length (mm) | Weight (kg) | Static Pressure Drop N/m <sup>2</sup> |      |      |      |      |       |       |      |
|------------------------------------|------------|------------|-------------|-------------|-------------|---------------------------------------|------|------|------|------|-------|-------|------|
|                                    |            |            |             |             |             | 1                                     | 2    | 3    | 4    | 5    | 6     | 7     | 8    |
| TXLB                               | 200        | 553        | 553         | 914         | 50          | 12                                    | 22   | 35   | 50   | 70   | 90    | 115   | 139  |
|                                    | 300        | 553        | 553         | 914         | 54          | 12                                    | 22   | 35   | 50   | 70   | 90    | 115   | 139  |
| <b>Silencer Face Velocity, m/s</b> |            |            |             |             |             | 3.81                                  | 5.08 | 6.35 | 7.62 | 8.89 | 10.16 | 11.43 | 12.7 |

## Dynamic Insertion Loss (DIL) Ratings: Forward (+) / Reverse (-) Flow

| IAC TXLB Model (length in mm) | Octave Band                               | 1  | 2   | 3   | 4   | 5  | 6  | 7  | 8  |
|-------------------------------|---|----|-----|-----|-----|----|----|----|----|
|                               | Hz  | 63 | 125 | 250 | 500 | 1K | 2K | 4K | 8K |
|                               | Silencer Face Velocity, m <sup>3</sup> /s |    |     |     |     |    |    |    |    |
| 200TXLB (914)                 | -10                                       | 10 | 14  | 26  | 20  | 17 | 14 | 12 | 9  |
|                               | -5  | 10 | 14  | 26  | 18  | 14 | 14 | 11 | 9  |
|                               | 0   | 9  | 13  | 25  | 17  | 14 | 13 | 10 | 8  |
|                               | +5  | 10 | 13  | 25  | 17  | 14 | 13 | 11 | 8  |
|                               | +10                                       | 10 | 13  | 24  | 19  | 16 | 14 | 12 | 8  |
| 300TXLB (914)                 | -10                                       | 7  | 8   | 21  | 20  | 15 | 11 | 9  | 4  |
|                               | -5  | 7  | 8   | 20  | 19  | 13 | 10 | 8  | 4  |
|                               | 0   | 5  | 6   | 18  | 17  | 11 | 9  | 7  | 3  |
|                               | +5  | 5  | 6   | 18  | 17  | 11 | 9  | 7  | 3  |
|                               | +10                                       | 6  | 7   | 18  | 19  | 14 | 10 | 8  | 3  |

### Note

- Silencer Face Area is the cross-sectional area at the silencer entrance
- Face Velocity is the airflow (m<sup>3</sup>/s) divided by the Face Area (m<sup>2</sup>)
- Pressure drop for any face velocity can be calculated from the equation:  
 $PD = (\text{Actual FV} / \text{catalogue FV})^2 \times (\text{Catalogue PD})$

# An Engineering Benchmark

In addition to providing HVAC silencers, IAC Acoustics is also able to provide the following solutions to noise control:

- Acoustic doors
- Acoustic windows
- Acoustic louvres
- Medical rooms
- Audiology booths
- Acoustic studios
- Acoustic wall treatments
- Anechoic chambers
- Acoustic barriers
- Acoustic enclosures
- Engine exhaust silencers
- Vent silencers
- Aero-engine test facilities
- Jet blast deflectors
- Ground run-up enclosures
- Gas turbine acoustic packages
- Anti-vibration mounts

Our wealth of engineering experience means that custom solutions can also be tailored for specific client applications. Please contact your local IAC Acoustics office should you require a unique solution.

## An Engineering Benchmark.

Our products are respected worldwide for their quality and certified performance. Rest assured that IAC Acoustics can deliver a solution to your unwanted noise problem.

# Contacts



## Head Office - Winchester, UK

T: +44 (0) 1962 873 000  
F: +44 (0) 1962 873 111  
E: winchester@iac-acoustics.com



## UAE - Dubai

T: +971 42 517 456  
F: +971 42 517 457  
E: dubai@iac-acoustics.com



## Australia

T: +61 (0) 2 8781 0400  
F: +61 (0) 2 9725 2939  
E: australia@iac-acoustics.com



## USA - Houston

T: +1 (832) 554 0980  
F: +1 (832) 554 0990  
E: houston@iac-acoustics.com



## Canada

T: +1 (905) 612 4000  
F: +1 (905) 612 8999  
E: toronto@iac-acoustics.com



## USA - Lincoln

T: +1 (402) 323 7272  
F: +1 (402) 323 7271  
E: lincoln@iac-acoustics.com



## China

T: +86 (0) 769 89899966 802  
F: +86 (0) 769 89899966 810  
E: china@iac-acoustics.com



## USA - New York

T: +1 (718) 931 8000  
F: +1 (718) 863 1138  
E: newyork@iac-acoustics.com



## Denmark

T: +45 36 77 88 00  
F: +45 36 78 12 30  
E: nordic@iac-acoustics.com



## France

T: +33 (0) 3 20 05 88 88  
F: +33 (0) 3 20 05 88 99  
E: france@iac-acoustics.com



## Germany

T: +49 (0) 2163 9991 0  
F: +49 (0) 2163 9991 23  
E: deutschland@iac-acoustics.com



## Italy

T: +39 02 48 44 22 1  
F: +39 02 48 44 22 22  
E: italia@iac-acoustics.com



## Spain

T: +34 93 321 6684  
F: +34 93 321 6249  
E: espana@iac-acoustics.com



**Making the world a quieter place**

