



“Reference,”

TOPSILENCE

DESIGN

Gerflor[®]
theflooringgroup



TOP
SILENCE



TOP
COMFORT



TOP
REALISM

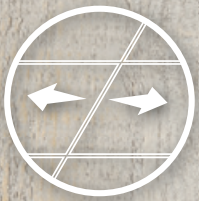

TOP
STABILITY



TOPSILENCE

DESIGN

229 x 1235 mm

298 x 620 mm

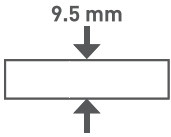

PUR+ MATT



Easy maintenance

4D DESIGN

STRUCTURED EMBOSS & BEVEL



Ultra realistic surface

MATT SURFACE



Natural look

CRISTAL WEAR LAYER



High definition design & color

COLLECTION

Wide variety of tiles & planks

HYBRID TECHNOLOGY

1 RESILIENT COMFORT CORE



Noise absorption



Soft underfoot

2 WOOD CORE



60°C
140°F
Max.

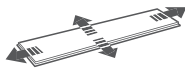

The best stability



Renovation ceramic
6 mm joint

NATURAL INSULATION

ACOUSTIC BACKING



16 dB

LOCK SYSTEM

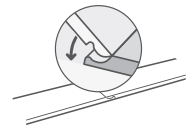

Standard laminate interlocking



TOPSILENCE

DESIGN

229 x 1235 mm



RUIVO BROWN



BRAGA



SINTRA



ARDA GOLDEN



TAVIRA CLEAR



CARVALHO

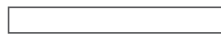

229 x 1235 mm



298 x 620 mm



PENICHE



ARDA PEARL



ESTRELA



DOURO

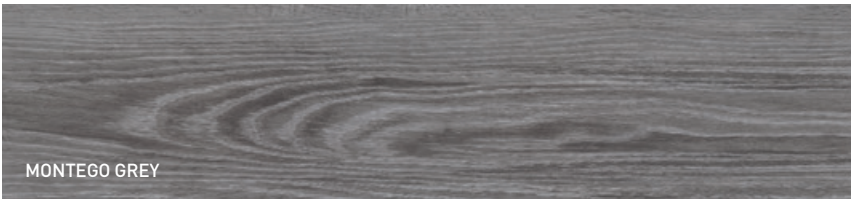

MONTEGO GREY

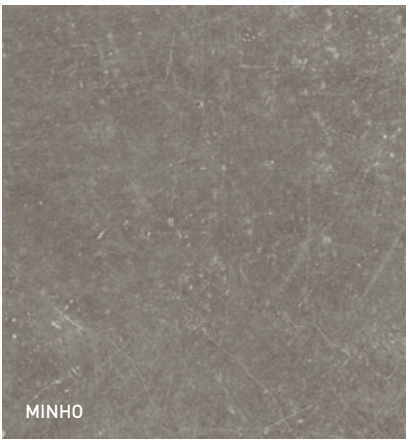

MINHO



NEGRA





RUIVO BROWN - 0006

229 x 1235 mm





BRAGA



SINTRA



BRAGA - 0015

229 x 1235 mm



SINTRA - 0005

229 x 1235 mm





ARDA GOLDEN



ARDA GOLDEN - 0009

229 x 1235 mm



ARDA PEARL - 0010

229 x 1235 mm



ARDA PEARL



ARDA PEARL



TAVIRA CLEAR - 0011

229 x 1235 mm





CARVALHO - 0007

229 x 1235 mm



PENICHE - 0004

229 x 1235 mm



ESTRELA - 0008

229 x 1235 mm

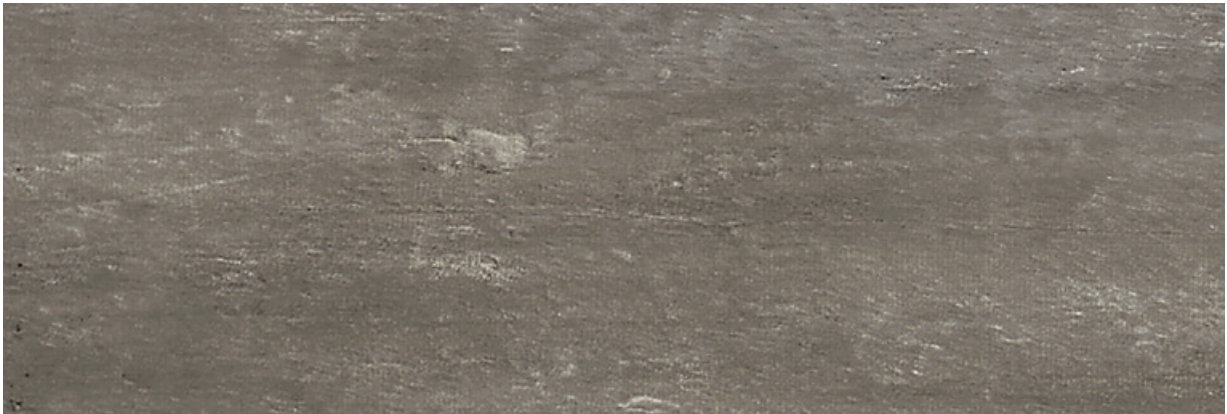

DOURO - 0003

229 x 1235 mm





ESTRELA



MONTEGO GREY



MONTEGO GREY - 0014

229 x 1235 mm





MINHO



MINHO - 0002

298 x 620 mm



NEGRA - 0001

298 x 620 mm



TOPSILENCE DESIGN
A FULL SET OF FINISHES

I DESIGN SKIRTING

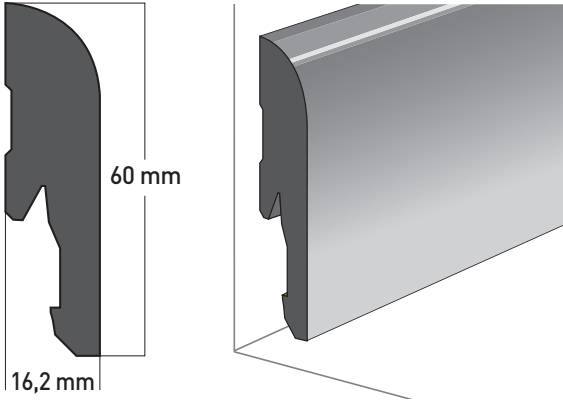

MDF design skirting
 Ref. 5947

- 100 % MATCHING DESIGNS
- Also available in white can be painted over



I OTHER SKIRTING

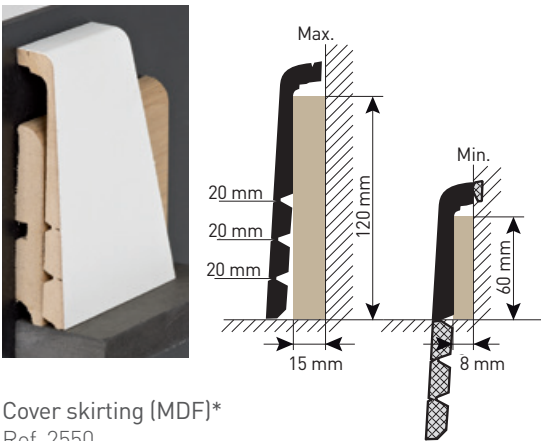

Cover skirting (MDF)*
 Ref. 2550



PROFILE

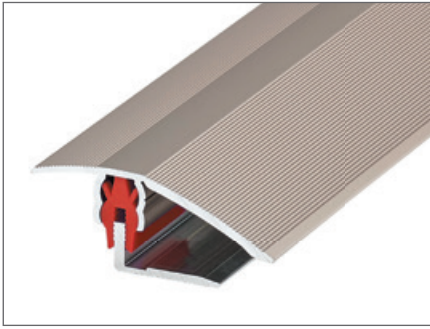

Aluminium profile*
Ref : 3143

FLOOR PROTECTION



Floor protection
Ref. 058X

ENTRANCE MAT













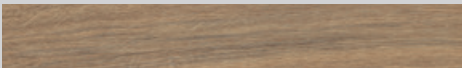

Quick mat
Ref. 1720

FOR MORE DETAILS
visit gerflor.com

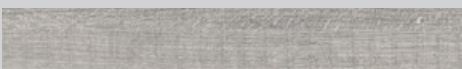

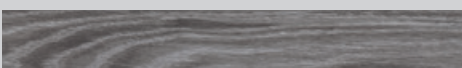
LVT finishes brochure

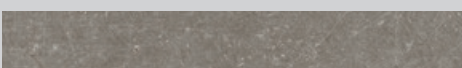
TOPSILENCE DESIGN
EQUIVALENCE TOPSILENCE DESIGN & CREATION

	TOPSILENCE DESIGN	CREATION
	DOURO - 0003	AMADOR - 0447
	PENICHE - 0004	ARENA - 0060
	SINTRA - 0005	BALLERINA - 0347
	RUIVO BROWN - 0006	CEDAR BROWN - 0850
	CARVALHO - 0007	MALUA BAY - 0448
	ESTRELA - 0008	RANCH - 0456
	ARDA GOLDEN - 0009	SWISS OAK GOLDEN - 0796
	ARDA PEARL - 0010	SWISS OAK PEARL - 0846
	TAVIRA CLEAR - 0011	TWIST - 0504
	MONTEGO GREY - 0014	OXFORD - 0061
	BRAGA - 0015	BUFFALO - 0457
	MINHO - 0002	CARMEL - 0618
	NEGRA - 0001	NORVEGIAN STONE - 0860

INSTALLATION



LOCK SYSTEM



CUTTING WITH A SAW

DESCRIPTION / BESCHREIBUNG / BESCHRIJVING / DESCRIPTION / DESCRIPCIÓN / DESCRIÇÃO / DESCRIZIONE

Total Thickness / Gesamtdicke / Totale dikte / Épaisseur totale / Espesor total / Espessura total / Spessore totale	EN ISO 24346 [EN 428]	mm	9.5
Weight / Flächengewicht / Gewicht / Poids / Peso / Peso / Peso	EN ISO 23997 [EN 430]	g/m ²	9880
Size / Format / Afmetingen / Format / Dimensiones / Dimensões / Dimensione	ISO 24342 [EN 427]	mm	229x1235 298x620
Number of planks /tiles and sqm per box	-	-	6 planks / 1.70 m ² / box 6 planks / 1.11 m ² / box

CLASSIFICATION / KLASSIFIKATION / CLASSIFICATIE / CLASSIFICATION / CLASIFICACIONES / CLASSIFICAÇÕES / CLASSIFICAZIONI

Norm/Product Specification / Produktnorm / Technische eigenschappen / Norme/ Spécification produit / Normas / Normas / Norma prodotto	-	-	EN 16511
European Classification / Europäische Klassifizierung / Europese classificatie / Classement européen / Clasificación europea / Classificação Europeia / Europea	EN ISO 10874 [EN 685]	Class	32
Fire Rating / Brandverhalten / Brand classificatie / Classement Feu / Fuego / Fogo / Reazione al fuoco	EN 13 501-1	Class	Bfl-s1
Static Electrical Propensity / Begehaufladung / Elektrische eigenschappen / Potentiel de charge / Comportamiento electrostático / Comportamento electrostático / Resistenza elettrica	EN 1815	kV	< 2
Slip Resistance Wet / Rutschhemmung / Anti-slip / Glissance humide / Deslizamiento húmedo / Escorregamento húmido / Scivolosità umida	DIN 51130 /BGR 181	Class	R10 ⁽¹⁾

PERFORMANCES / TECHNISCHE EIGENSCHAFTEN / TESTRESULTAAT / PERFORMANCE / CUALIDADES TÉCNICAS / PERFORMANCES / CARATTERISTICHE TECNICHE

Impact sound insulation / Trittschallverbesserungsmaß / Geluidsisolatie / Isolation acoustique bruits de chocs / Acústica / Isolamento acústico	EN ISO 717-2	dB	16
Dimensional Stability / Maßstabilität / Maatvastheid / Stabilité dimensionnelle / Estabilidad dimensional / Estabilidade dimensional / Stabilità dimensionale	EN ISO 23999 [EN 434]	%	≤ 0.15
Residual Indentation / Resteindruck / Indrukbelasting / Poinçonnement statique rémament / Punzonamiento / Punçoamento / Impronta	EN ISO 24343-1 [EN 433]	mm	≤ 0.10
Castor chair test / Stuhlrollenbeanspruchung / Rolweerstand bureaustoelen / Essai de la chaise à roulettes / Determinación del efecto de una silla con ruedas / Resistência a cadeiras de rodas / Resistenza al passaggio di sed (Type W)	ISO 4918 [EN 425]	-	OK
Thermal Conductivity / Wärmeleitfähigkeit / Thermische weerstand / Conductivité thermique / Conductividad térmica / Contutividade térmica / Resistenza termica / Värmeledningsmotstånd / Varmemotstånd	EN ISO 10456 [EN12524]	W/(m.K)	0.25
Colour Fastness / Lichtechtheit / Lichtechtheid / Solidité lumière / Resistencia a la luz / Estabilidade das cores / Solidità alla luce	EN 20 105 - B02	degree	≥ 6
Surface Treatment / Oberflächenvergütung / Oppervaktebehandling / Traitement de surface / Tratamiento de superficie / Tratamento de superficie / Trattamento di superficie	-	-	PUR+ MATT
Chemical Products Resistance / Verhalten gegenüber Chemikalien / Chemische bestendigheid / Résistance aux produits chimiques / Resistencia a los productos químicos / Resistência aos produtos químicos / Resistenza ai prodotti chimici ⁽²⁾	EN ISO 26987 [EN 423]	-	OK

ENVIRONMENT/INDOOR AIR QUALITY / UMWELT/RAUMLUFTQUALITÄT / ENVIRONNEMENT/QUALITE DE L'AIR INTERIEUR / MEDIO AMBIENTE/CALIDAD INTERIOR DEL AIRE INTERIOR / MEIO AMBIENTE/QUALIDADE DO AR INTERIOR

TVOC after 28 days / TVOC (28 Tage) / TVOC (28 dagen) / TVOC après 28 jours / TVOC (28 dias) / TVOC (28 dias) / TVOC (28 giorni) / TVOC (28 dagar) / TVOC (28 dager)	ISO 16000-6	µg/m ³	< 100
---	-------------	-------------------	-------

CE MARKING / CE KENNZEICHNUNG / EG_CONFORMITEITSMERK / MARQUAGE CE / MARCA DE CONFORMIDAD CE / MARCA DE CONFORMIDADE CE / MARCATURA CE DI CONFORMITA

CE	EN 14041	-	   
----	----------	---	---

(1) Glissance humide / Slip resistance wet / Rutschhemmung : details sur site gerflor.com / details on website gerflor.com / Einzelheiten auf der web-site gerflor.com

(2) Beständig gegenüber nicht färbenden alkoholhaltigen Handdesinfektionsmitteln, Haushaltschemikalien und verdünnten Säuren und Laugen bei kurzzeitiger Einwirkung.

TOP SILENCE DESIGN, NO ADHESIVE, MORE COMFORT



COMPOSITION
100% REACH
Phthalate Free
Cork backing



INDOOR AIR QUALITY
TVOC below detection level
10 times lower than norms requirements
(TVOC < 100ug/m³ after 28 days)



RECYCLED CONTENT
60%



INSTALLATION
Adhesive Free



WELLNESS
Walking noise reduction:
-10dB vs laminate

Gerflor International
Tel: +33 (0)4 74 05 40 00
Fax: +33 (0)4 74 05 03 13
e-mail: gerflorcontract@gerflor.com

Visualize your reference



interiordesigner.gerflor.com

30 years experience
Since 1985

Manufacturer
3 LVT Factories

World Class Logistics
12 Logistics Hubs

Gerflor Design Centre
Exclusive Designs



“Serenity,,
Elodie - **End User**



“Time saving,,
Mika - **Installer**



“Unique Design,,
Pierre - **Architect**



“Confidence,,
Claire - **Store Manager**



“Reliability,,
Lucas - **Distributor**

That's why Gerflor is our **Reference**

Gerflor[®]
theflooringgroup