

Tværsnit

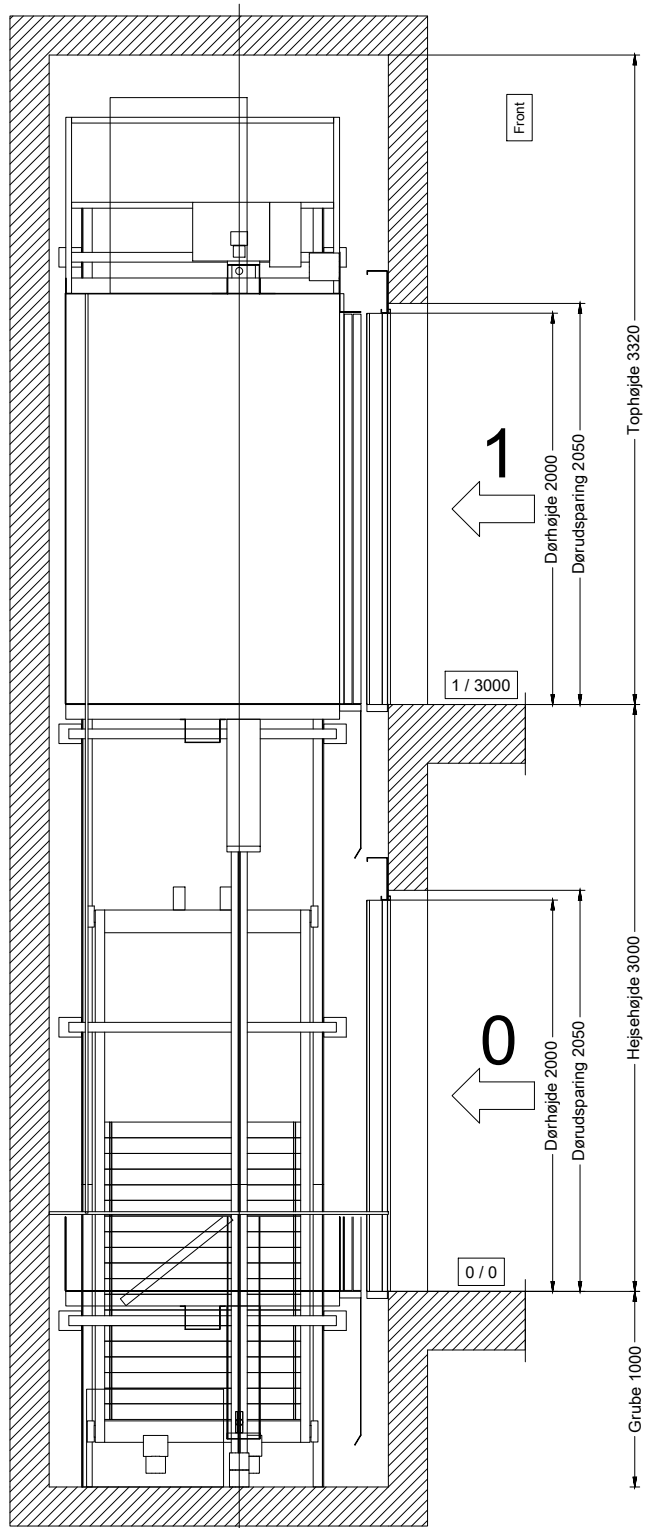

Plansnit

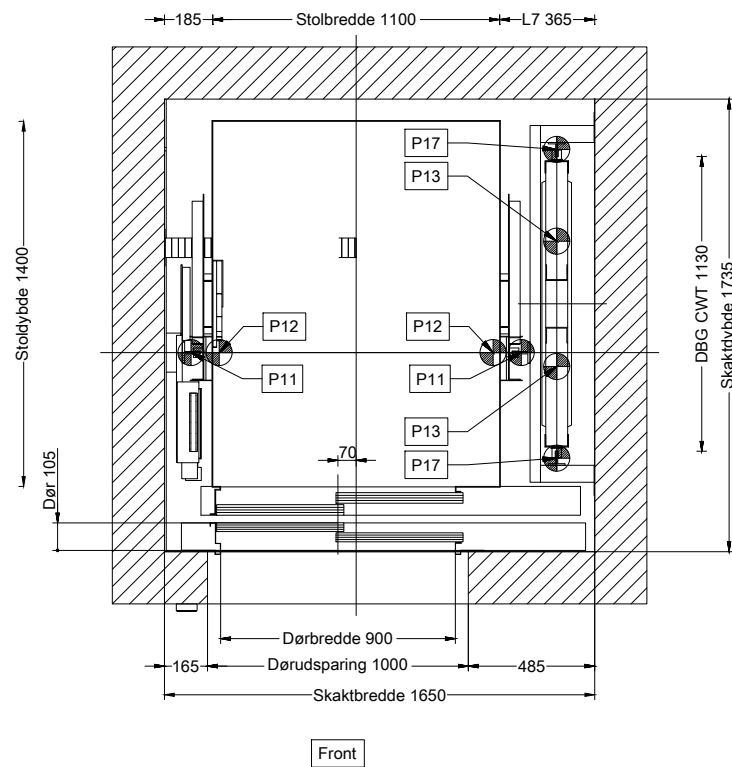

Plansnit
Etage 1

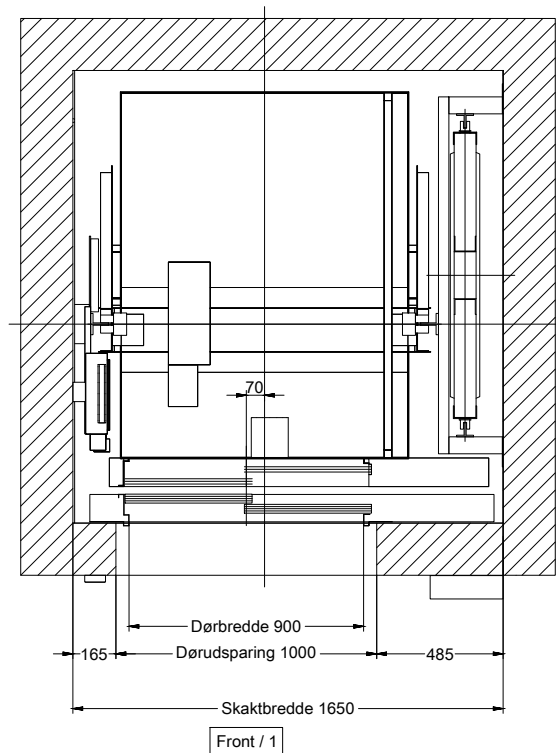

Etagedør (0)
Front Set fra etage

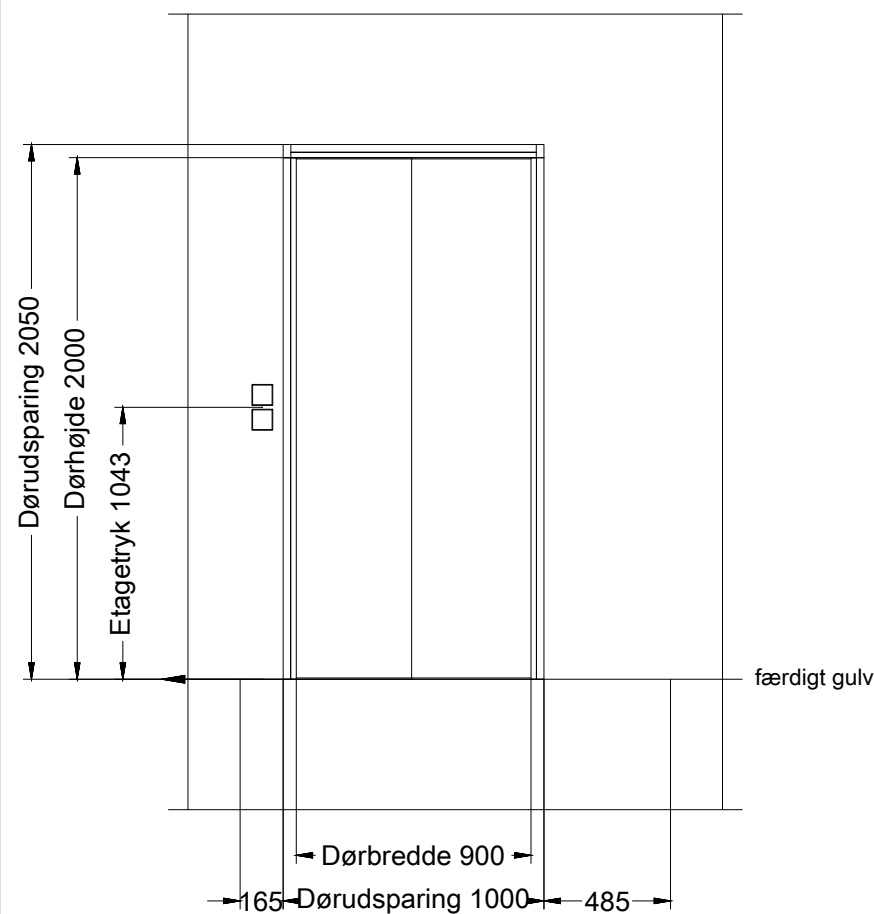

Etagedør (1)
Front Set fra etage



Fremvisningstegning

TEKNISK AFSNIT (OTIS)

Elevatormummer:
Genesis 8 pers / 630 kg 1ENT

Os A/S
Ellekær 9a
DK-2730 Herlev
www.otis.com
Telefon: +45 44 88 89 99
Fax: +45 44 88 89 90

Projekt:
Kim Abel Test 2

GENESIS - GF0882CG
8D - 630 kg - 1 m/s

Tekening gecontroleerd

Ændringer:	
A	08 Nov 2021 Abel Kim
a	

Tværsnit

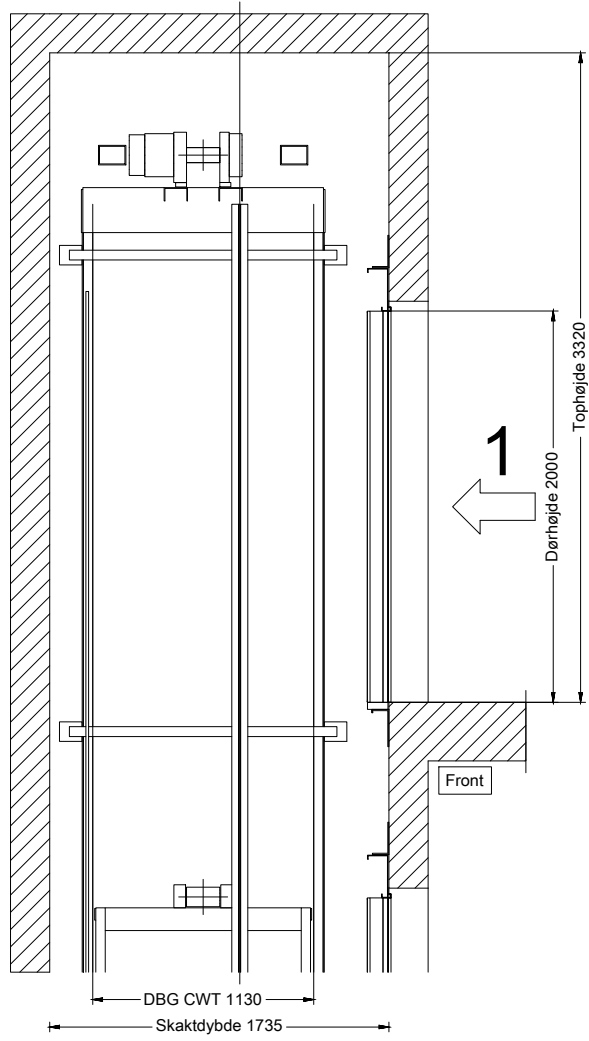

Ventilation øverst i skakten
min 1% of tværsnitareal
udført af andre

Tværsnit

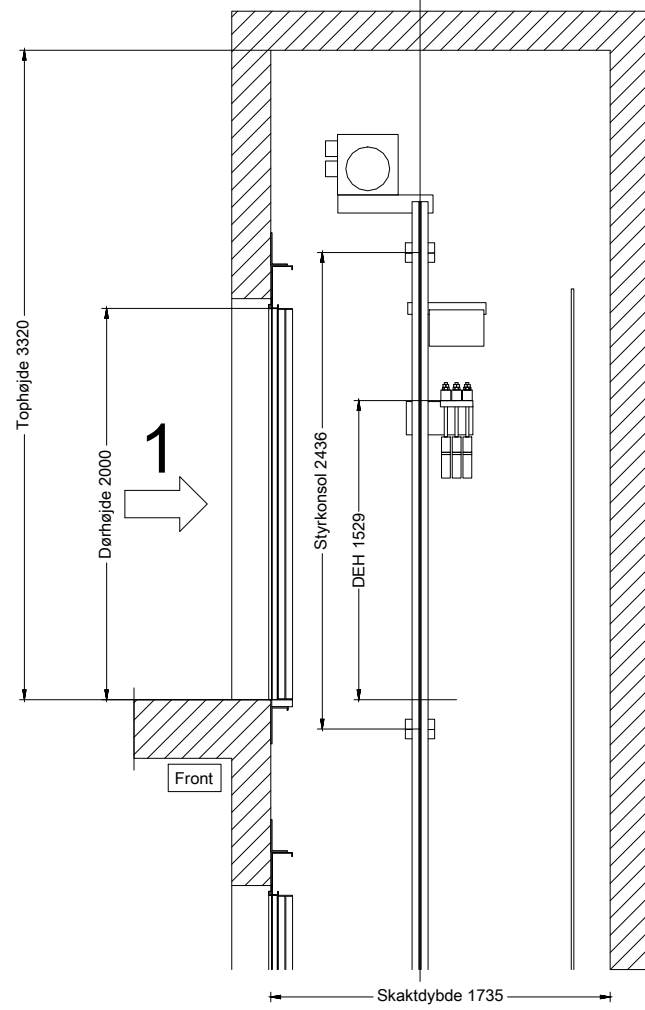

Plansnit
Etage 1
Reaktioner i grubebund

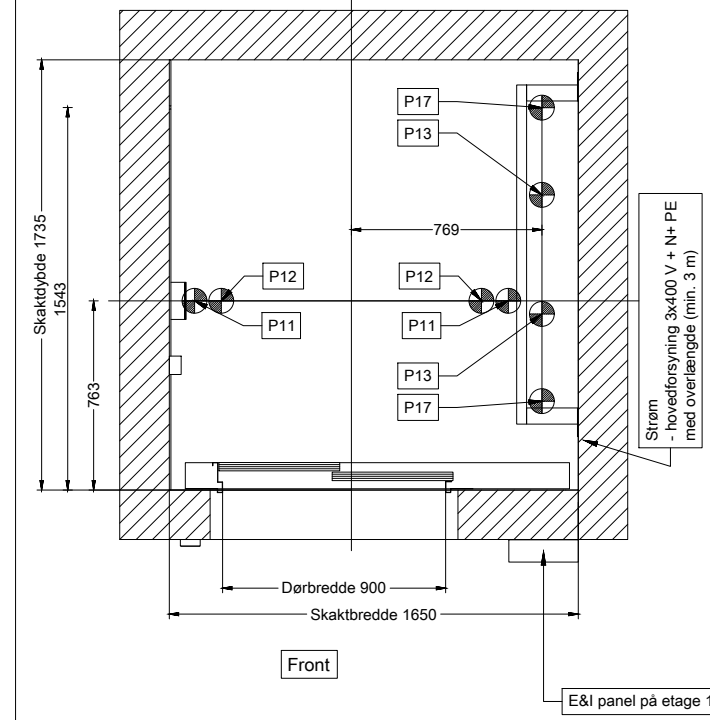

Plansnit
Krogplacering i skakttop

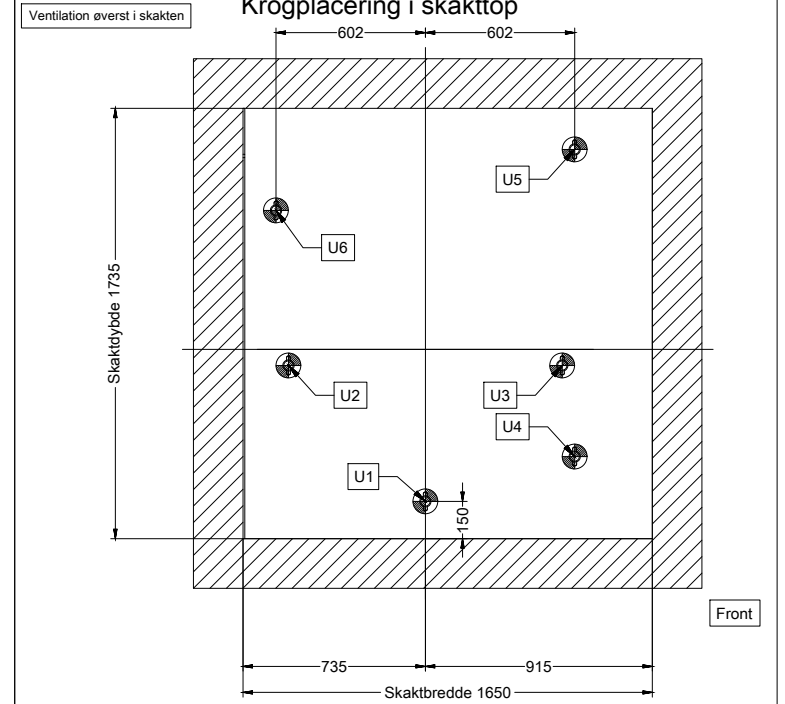

Betonlysning
Etage (1)

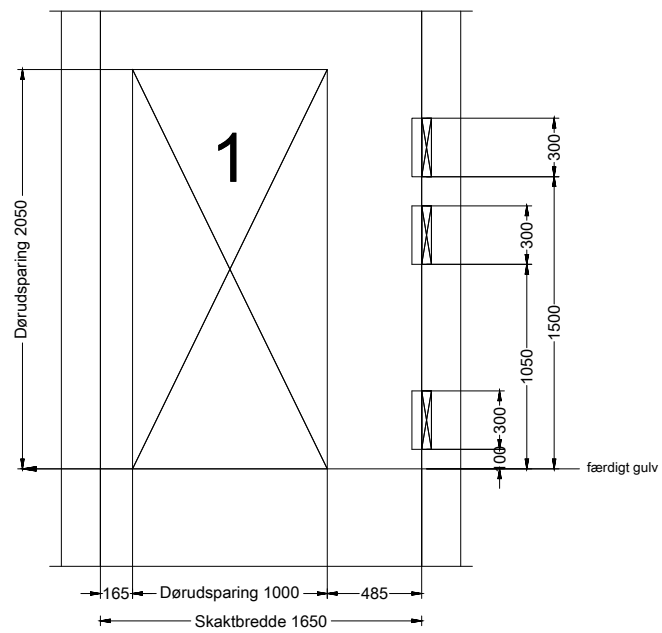

Betonlysning
(1)

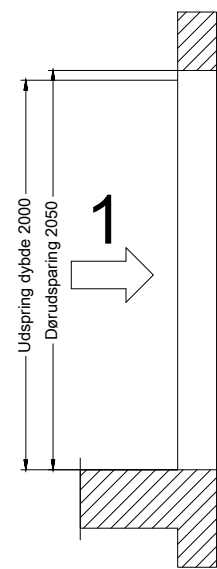

Fremvisningstegning

TEKNISK AFSNIT (OTIS)

Elevatormummer:
Genesis 8 pers / 630 kg 1ENT

Otis A/S
Ellekær 9a
DK-2730 Herlev
www.otis.com
Telefon: +45 44 88 89 99
Fax: +45 44 88 89 90

Projekt:
Kim Abel Test 2

GENESIS - GF0882CG
8D - 630 kg - 1 m/s

Tegningsnummer:

2 Sider
Side: 2

Ændringer:	
A	08 Nov 2021 Abel Kim
a	