

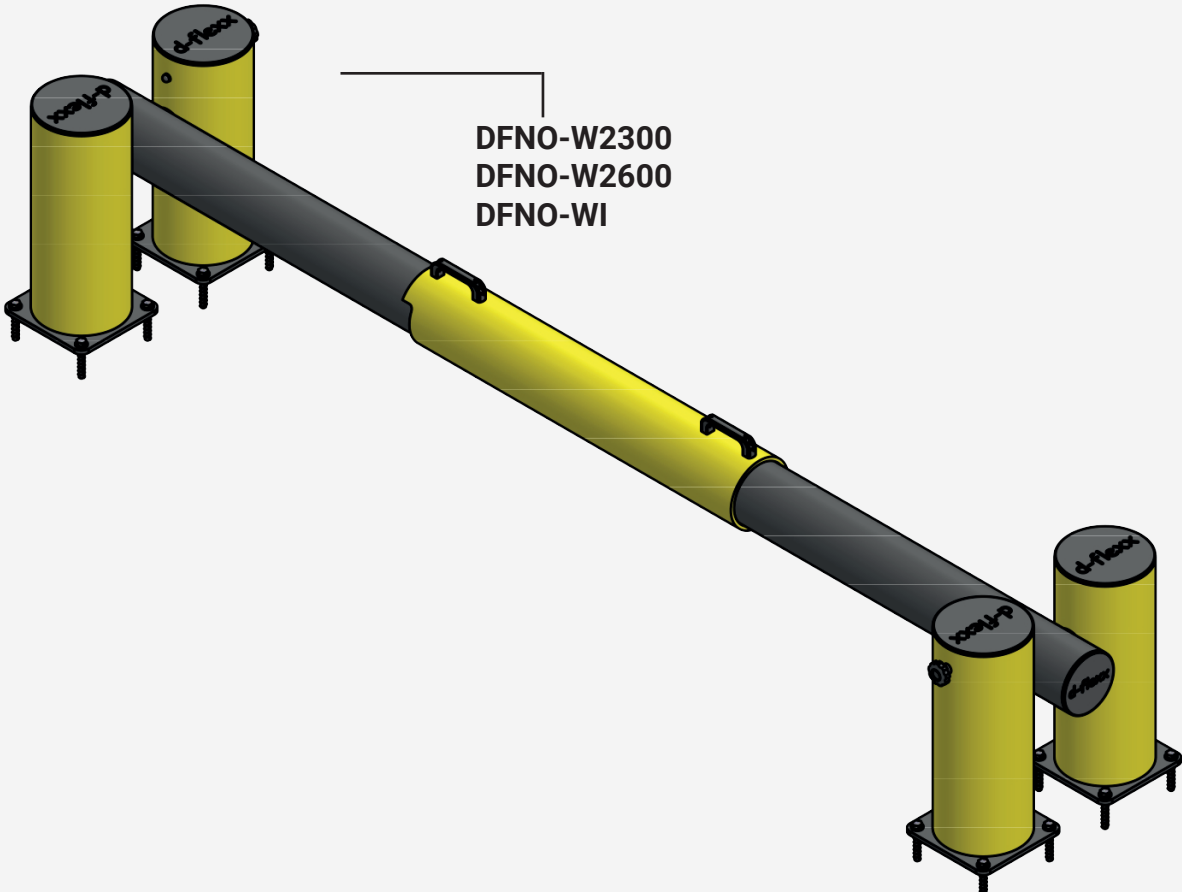

# Dock Gate - NOVEMBER



# Table of contents

Art. No.	Description	Width inside	Installation width	Weight	Page
DFNO-W2300	Dock Gate	2300 mm	2777 mm	56,2 kg	3
DFNO-W2600	Dock Gate	2600 mm	3077mm	58,3 kg	3
DFNO-WI	Dock Gate	2300 - 3300 mm	2777 - 3777 mm		4

## Technical Information

### Material properties

Operational temperature range	-40° up to + 50°
Ignition Temperature	350 - 360°C
Flash Point	350 - 360°C
Toxicity	Nontoxic
Chemical Resistance	high - ISO/TR 10358
Hygiene Seals	Non
Standard Warranty	5 years

### Deflection Zone:

**I** 250 mm

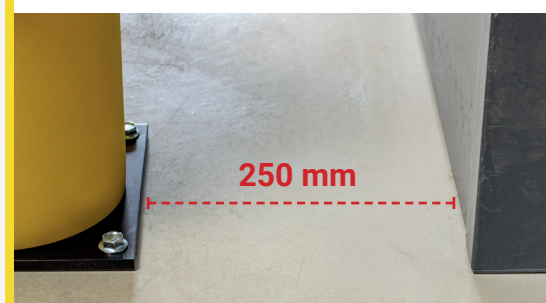

# DFNO-W2300

Article description	Dock Gate
Item number	DFNO-W2300
EAN	4250912395886
Customs tariff number	39269097
Width (mm)	2777
Height (mm)	500
Depth/Length (mm)	585
Installation width (mm)	2777
Width inside (mm):	2300
Depth without foot plate (mm):	535
Deflection zone (mm)	250
Tested to withstand force (Joule):	N/A
Net weight	56,2 kg
Material	Polyethylene
Color	Yellow RAL 1018 - black
Area of application	Indoor and outdoor use
Fixing	Fixing Material included. 16 x concrete screw M12x80

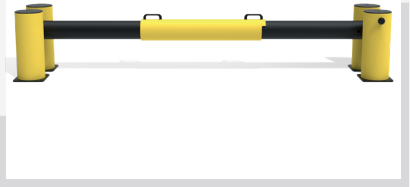
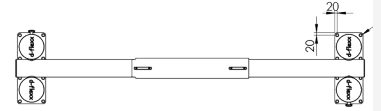
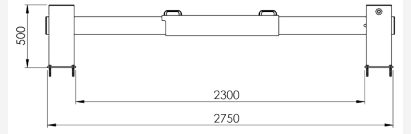

# DFNO-W2600

Article description	Dock Gate
Item number	DFNO-W2600
EAN	4250912395978
Customs tariff number	39269097
Width (mm)	3077
Height (mm)	500
Depth/Length (mm)	585
Installation width (mm)	3077
Width inside (mm):	2600
Depth without foot plate (mm):	235
Deflection zone (mm)	250
Tested to withstand force (Joule):	N/A
Net weight	58,3 kg
Material	Polyethylene
Color	Yellow RAL 1018 - black
Area of application	Indoor and outdoor use
Fixing	Fixing Material included. 16 x concrete screw M12x80

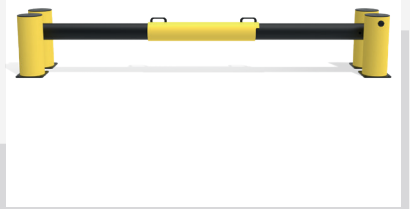
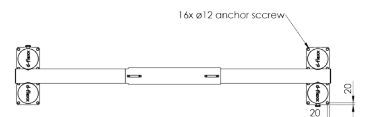

# DFNO-WI

Article description	Dock Gate
Item number	DFNO-WI
EAN	4250912395961
Customs tariff number	39269097
Width (mm)	2777-3777
Height (mm)	500
Depth/Length (mm)	585
Installation width (mm)	2777-3777
Width inside (mm):	2300-3300
Depth without foot plate (mm):	535
Deflection zone (mm)	250
Tested to withstand force (Joule):	N/A
Net weight	N/A
Material	Polyethylene
Color	Yellow RAL 1018 - black
Area of application	Indoor and outdoor use
Fixing	Fixing Material included. 16 x concrete screw M12x80

